

34mm Half Bridge IGBT Module

$V_{CES} = 1200V$, $I_{C\ nom} = 75A$ / $I_{CRM} = 150A$

Features :

- 1200V Trench / Field Stop process
- Low switching losses
- V_{cesat} has a positive temperature coefficient

Applications:

- Inverter welding machine
- induction heating
- high-frequency switch power supply
- inverter

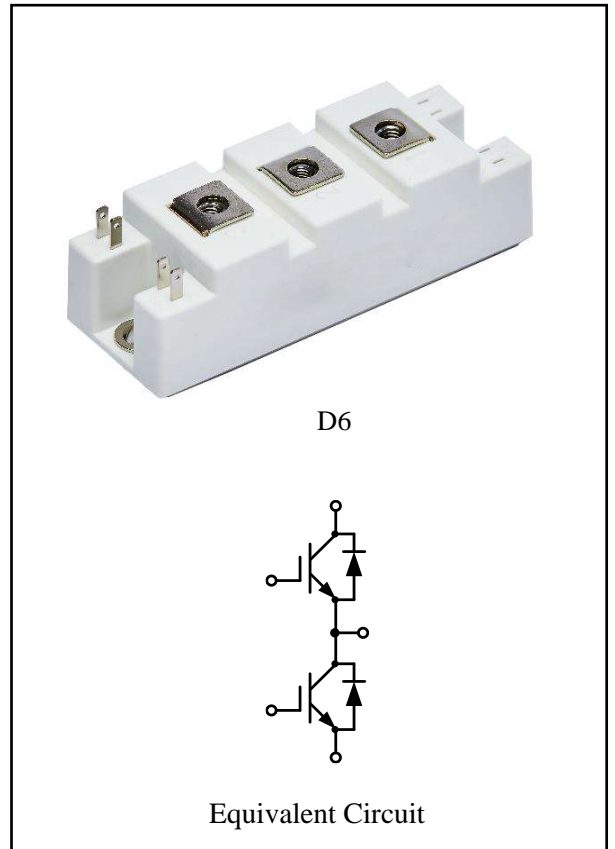

IGBT, Inverter

Maximum Ratings

Parameter	Conditions	Symbol	Value	Unit
Collector-Emitter voltage	$T_{vj} = 25^{\circ}C$	V_{CES}	1200	V
Continuous DC collector current	$T_C = 100^{\circ}C$, $T_{vj\ max} = 175^{\circ}C$	$I_{C\ nom}$	75	A
Repetitive peak collector current	$t_P = 1\ ms$	I_{CRM}	150	A
Total power dissipation	$T_C = 25^{\circ}C$, $T_{vj\ max} = 175^{\circ}C$	P_{tot}	395	W
Gate emitter voltage		V_{GE}	± 20	V

Characteristic Values

Parameter	Conditions	Symbol	Value			Unit
			Min.	Typ.	Max.	
Collector-Emitter saturation voltage	$V_{GE}=15V, I_C=75A$ $V_{GE}=15V, I_C=75A$ $V_{GE}=15V, I_C=75A$	$T_{vj}=25^{\circ}C$ $T_{vj}=125^{\circ}C$ $T_{vj}=150^{\circ}C$	V_{CEsat}	1.98 2.45 2.56	2.50	V
Gate-Emitter threshold voltage	$I_C = 2.6mA, V_{GE}= V_{CE}$	$T_{vj}=25^{\circ}C$	$V_{GE(th)}$	5.10	5.70	6.30
Gate charge	$V_{GE}=-15V...+15V$		Q_G	0.36		μC
Internal gate resistor			R_{Gint}	6.00		Ω
Input capacitance	$f=1MHz, V_{CE}=25V, V_{GE}=0V$	$T_{vj}=25^{\circ}C$	C_{ies}	4.49		nF
Reverse transfer capacitance			C_{res}	0.20		
Collector-emitter cut-off current	$V_{CE}=1200V, V_{GE}=0V$	$T_{vj}=25^{\circ}C$	I_{CES}		1	mA
Gate-emitter leakage current	$V_{CE}=0V, V_{GE}=20V$	$T_{vj}=25^{\circ}C$	I_{GES}		100	nA
Turn-on delay time	$I_C=75A, V_{CE}=600V$ $V_{GE}=\pm 15V, R_G=10\Omega$ (inductive load)	$T_{vj}=25^{\circ}C$ $T_{vj}=125^{\circ}C$ $T_{vj}=150^{\circ}C$	t_{don}	97 107 111		ns
Rise time	$I_C=75A, V_{CE}=600V$ $V_{GE}=\pm 15V, R_G=10\Omega$ (inductive load)	$T_{vj}=25^{\circ}C$ $T_{vj}=125^{\circ}C$ $T_{vj}=150^{\circ}C$	t_r	47 58 63		
Turn-off delay time	$I_C=75A, V_{CE}=600V$ $V_{GE}=\pm 15V, R_G=10\Omega$ (inductive load)	$T_{vj}=25^{\circ}C$ $T_{vj}=125^{\circ}C$ $T_{vj}=150^{\circ}C$	t_{doff}	242 280 289		
Fall time	$I_C=75A, V_{CE}=600V$ $V_{GE}=\pm 15V, R_G=10\Omega$ (inductive load)	$T_{vj}=25^{\circ}C$ $T_{vj}=125^{\circ}C$ $T_{vj}=150^{\circ}C$	t_f	119 142 135		
Turn-on energy loss per pulse	$I_C=75A, V_{CE}=600V$ $V_{GE}=\pm 15V, R_G=10\Omega$ (inductive load)	$T_{vj}=25^{\circ}C$ $T_{vj}=125^{\circ}C$ $T_{vj}=150^{\circ}C$	E_{on}	6.72 10.62 11.89		
Turn-off energy loss per pulse	$I_C=75A, V_{CE}=600V$ $V_{GE}=\pm 15V, R_G=10\Omega$ (inductive load)	$T_{vj}=25^{\circ}C$ $T_{vj}=125^{\circ}C$ $T_{vj}=150^{\circ}C$	E_{off}	3.16 4.09 4.41		mJ
Thermal resistance, junction to case	per IGBT		R_{thJC}		0.38	K/W
Temperature under switching conditions			$T_{vj op}$	-40	150	$^{\circ}C$

Diode, Inverter

Maximum Ratings

Parameter	Conditions	Symbol	Value	Unit
Repetitive peak reverse voltage	$T_{vj}=25^{\circ}\text{C}$	V_{RRM}	1200	V
Continuous DC forward current		I_F	60	A
Repetitive peak forward current	$t_p=1\text{ms}$	I_{FRM}	120	A
I^2t -value	$t_p=10\text{ms}$, $\sin 180^{\circ}$, $T_j=125^{\circ}\text{C}$	I^2t	1200	A^2s

Characteristic Values

Parameter	Conditions	Symbol	Value			Unit
			Min.	Typ.	Max.	
Forward voltage	$I_F=60\text{A}$, $V_{GE}=0\text{V}$ $T_{vj}=25^{\circ}\text{C}$	V_F		1.90	2.40	V
	$I_F=60\text{A}$, $V_{GE}=0\text{V}$ $T_{vj}=125^{\circ}\text{C}$			1.62		
	$I_F=60\text{A}$, $V_{GE}=0\text{V}$ $T_{vj}=150^{\circ}\text{C}$			1.54		
Peak reverse recovery current	$I_F=60\text{A}$, $-di_F/dt=900\text{A}/\mu\text{s}$ ($T_{vj}=150^{\circ}\text{C}$) $V_R=600\text{V}$, $V_{GE}=-15\text{V}$	I_{RM}		29		A
	$T_{vj}=125^{\circ}\text{C}$			43		
	$T_{vj}=150^{\circ}\text{C}$			48		
Recovered charge	$I_F=60\text{A}$, $-di_F/dt=900\text{A}/\mu\text{s}$ ($T_{vj}=150^{\circ}\text{C}$) $V_R=600\text{V}$, $V_{GE}=-15\text{V}$	Q_r		5.46		μC
	$T_{vj}=125^{\circ}\text{C}$			11.68		
	$T_{vj}=150^{\circ}\text{C}$			13.88		
Reverse recovered energy	$I_F=60\text{A}$, $-di_F/dt=900\text{A}/\mu\text{s}$ ($T_{vj}=150^{\circ}\text{C}$) $V_R=600\text{V}$, $V_{GE}=-15\text{V}$	E_{rec}		2.07		mJ
	$T_{vj}=125^{\circ}\text{C}$			4.26		
	$T_{vj}=150^{\circ}\text{C}$			5.06		
Thermal resistance, junction to case	每个二极管 / per diode	R_{thJC}			0.58	K/W
Temperature under switching conditions		$T_{vj\ op}$	-40		150	$^{\circ}\text{C}$

Module

Parameter	Conditions	Symbol	Value			Unit
Isolation test voltage	RMS, $f=50\text{Hz}$, $t=1\text{min}$	V_{ISOL}	4000			V
Internal isolation			Al_2O_3			
Storage temperature		T_{stg}	-40		125	$^{\circ}\text{C}$
Mounting torque for modul mounting		M	3.0		6.0	Nm
Weight		W		155		g

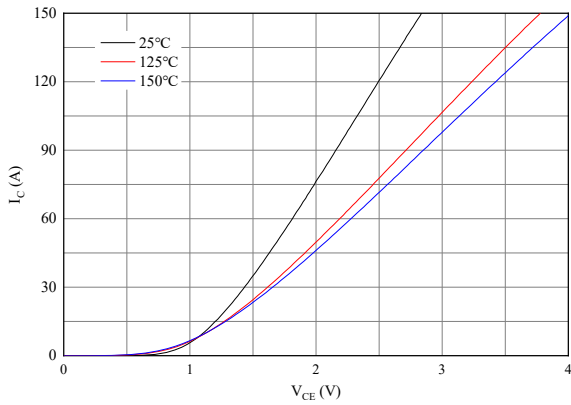

Fig 1. Typical output characteristics ($V_{GE}=15V$)

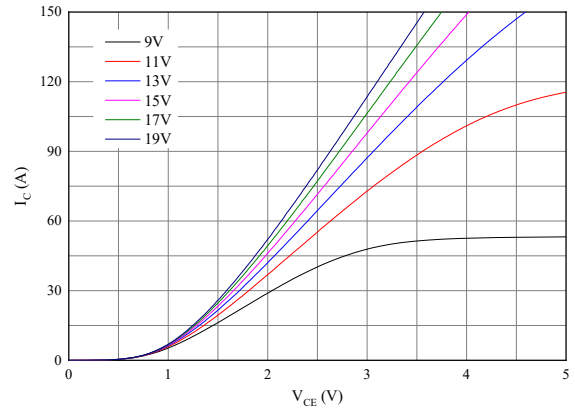

Fig 2. Typical output characteristics ($T_{vj}=150^{\circ}C$)

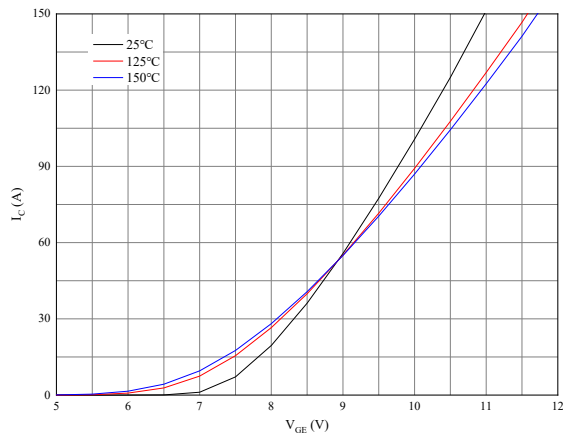

Fig 3. Typical transfer characteristic ($V_{CE}=20V$)

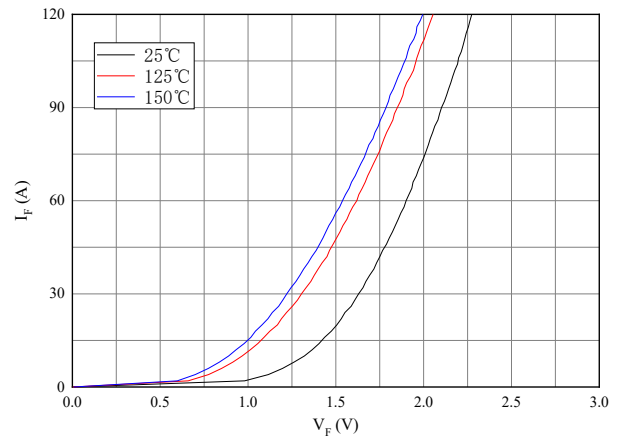

Fig 4. Forward characteristic of Diode

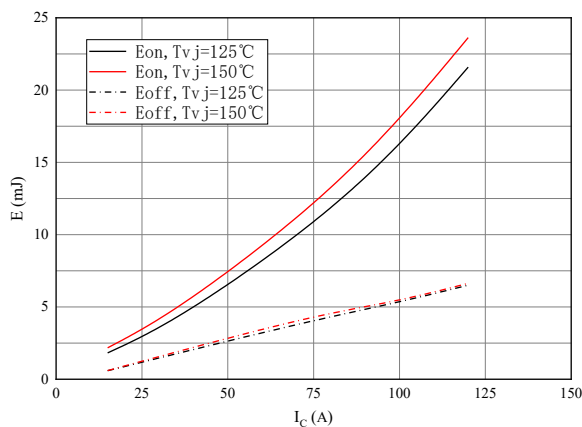

Fig 5. Switching losses of IGBT
 $V_{GE}=\pm 15V, R_{Gon}=10\Omega, R_{Goff}=10\Omega, V_{CE}=600V$

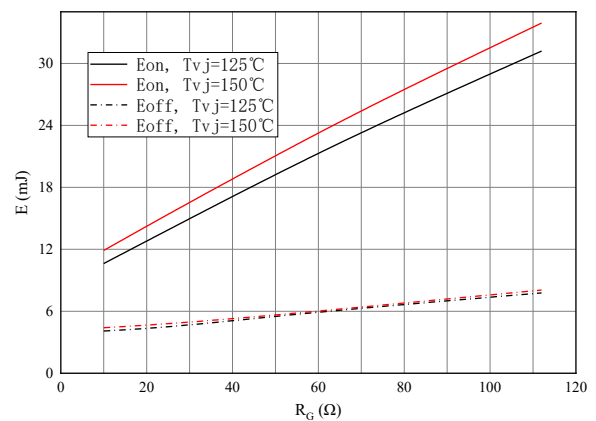

Fig 6. Switching losses of IGBT
 $V_{GE}=\pm 15V, I_C=75A, V_{CE}=600V$

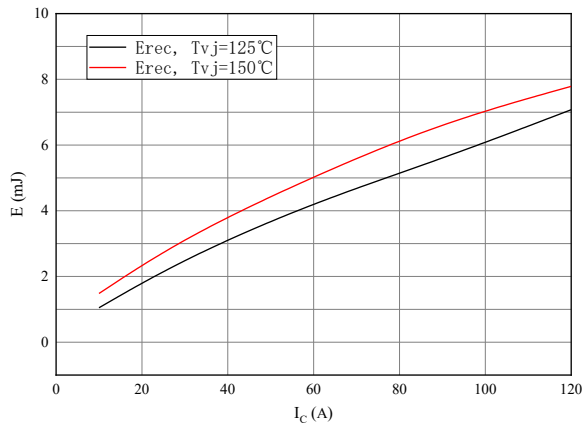

Fig 7. Switching losses of Diode
 $R_{Gon}=10\Omega, V_{CE}=600V$

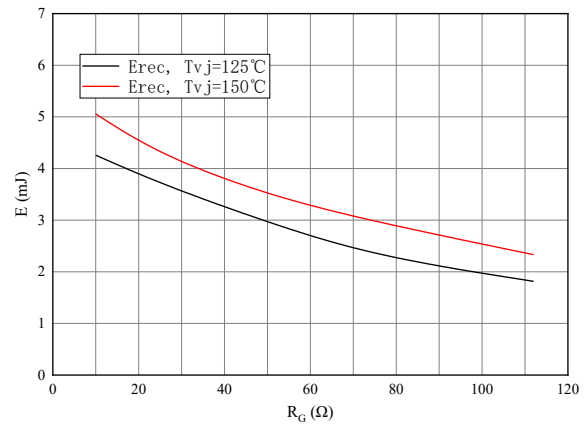

Fig 8. Switching losses of Diode
 $I_F=60A, V_{CE}=600V$

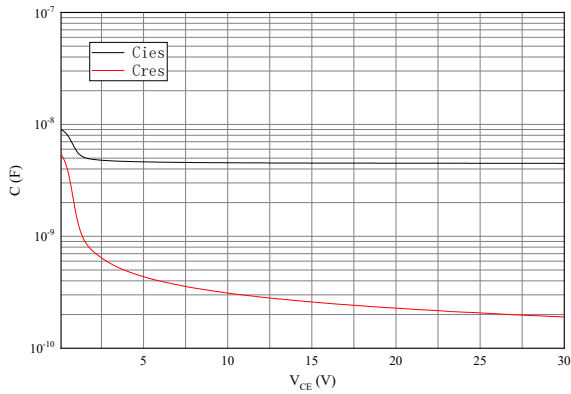
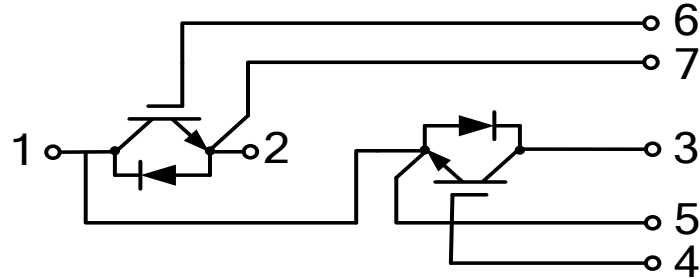

Fig 9. Capacitance characteristic

Circuit diagram



Package outlines

