

PIM IGBT Module

$V_{CES} = 1200V$, $I_{C\ nom} = 10A$ / $I_{CRM} = 20A$

Features :

- 1200V Trench /Field Stop process
- Low switching losses
- V_{cesat} has a positive temperature coefficient

Applications:

- Variable Frequency Drive
- Servo drive
- Inverter

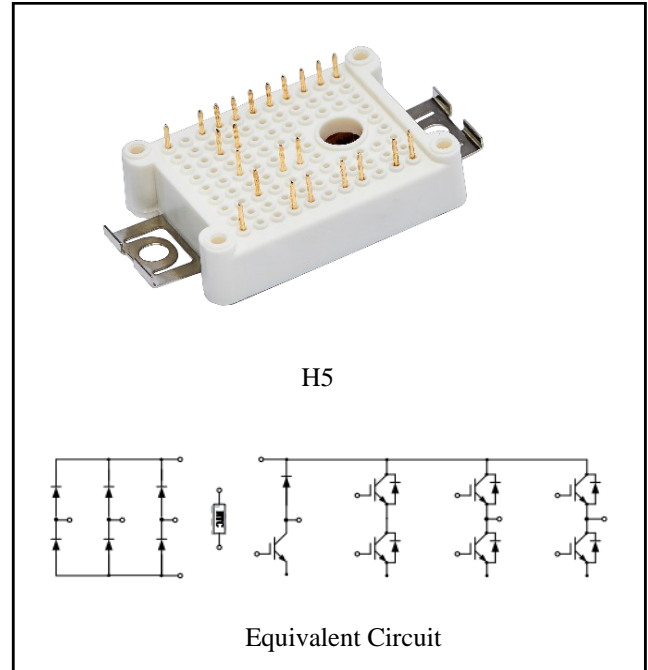

IGBT, Inverter

Maximum Ratings

Parameter	Conditions	Symbol	Value	Unit
Collector-Emitter voltage	$T_{vj} = 25^{\circ}C$	V_{CES}	1200	V
Continuous DC collector current	$T_C = 100^{\circ}C$, $T_{vj\ max} = 175^{\circ}C$	$I_{C\ nom}$	10	A
Repetitive peak collector current	$t_p = 1\ ms$	I_{CRM}	20	A
Total power dissipation	$T_C = 25^{\circ}C$, $T_{vj\ max} = 175^{\circ}C$	P_{tot}	105	W
Gate emitter voltage		V_{GE}	± 20	V

Characteristic Values

Parameter	Conditions	Symbol	Value			Unit
			Min.	Typ.	Max.	
Collector-Emitter saturation voltage	$V_{GE} = 15V$, $I_C = 10A$ $T_{vj} = 25^{\circ}C$ $V_{GE} = 15V$, $I_C = 10A$ $T_{vj} = 125^{\circ}C$ $V_{GE} = 15V$, $I_C = 10A$ $T_{vj} = 150^{\circ}C$	V_{CEsat}		1.71 1.97 2.05	2.10	V
Gate-Emitter threshold voltage	$I_C = 0.30mA$, $V_{GE} = V_{CE}$ $T_{vj} = 25^{\circ}C$	$V_{GE(th)}$	5.0	5.6	6.2	
Internal gate resistor		R_{Gint}		None		Ω

Gate charge	$V_{GE} = -15V \dots +15V$	Q_G	0.10		μC
Input capacitance	$f = 1MHz, V_{CE} = 25V, V_{GE} = 0V \quad T_{vj} = 25^\circ C$	C_{ies}	0.88		nF
Reverse transfer capacitance		C_{res}	0.04		
Collector-emitter cut-off current	$V_{CE} = 1200V, V_{GE} = 0V \quad T_{vj} = 25^\circ C$	I_{CES}		1	mA
Gate-emitter leakage current	$V_{CE} = 0V, V_{GE} = 20V \quad T_{vj} = 25^\circ C$	I_{GES}		100	nA
Turn-on delay time	$I_C = 10A, V_{CE} = 600V$ $V_{GE} = \pm 15V, R_G = 40\Omega$ (inductive load)	$T_{vj} = 25^\circ C$ $T_{vj} = 125^\circ C$ $T_{vj} = 150^\circ C$	t_{don}	48	
				45	
				44	
Rise time	$I_C = 10A, V_{CE} = 600V$ $V_{GE} = \pm 15V, R_G = 40\Omega$ (inductive load)	$T_{vj} = 25^\circ C$ $T_{vj} = 125^\circ C$ $T_{vj} = 150^\circ C$	t_r	34	
				36	
				37	
Turn-off delay time	$I_C = 10A, V_{CE} = 600V$ $V_{GE} = \pm 15V, R_G = 40\Omega$ (inductive load)	$T_{vj} = 25^\circ C$ $T_{vj} = 125^\circ C$ $T_{vj} = 150^\circ C$	t_{doff}	240	ns
				283	
				294	
Fall time	$I_C = 10A, V_{CE} = 600V$ $V_{GE} = \pm 15V, R_G = 40\Omega$ (inductive load)	$T_{vj} = 25^\circ C$ $T_{vj} = 125^\circ C$ $T_{vj} = 150^\circ C$	t_f	175	
				202	
				276	
Turn-on energy loss per pulse	$I_C = 10A, V_{CE} = 600V$ $V_{GE} = \pm 15V, R_G = 40\Omega$ (inductive load)	$T_{vj} = 25^\circ C$ $T_{vj} = 125^\circ C$ $T_{vj} = 150^\circ C$	E_{on}	0.87	mJ
				1.27	
				1.40	
Turn-off energy loss per pulse	$I_C = 10A, V_{CE} = 600V$ $V_{GE} = \pm 15V, R_G = 40\Omega$ (inductive load)	$T_{vj} = 25^\circ C$ $T_{vj} = 125^\circ C$ $T_{vj} = 150^\circ C$	E_{off}	0.67	
				0.85	
				0.89	
SC data	$V_{GE} \leq 15V, V_{CC} = 800V$ $V_{CEmax} = V_{CES} - L_{sCE} \cdot di/dt \quad t_p \leq 10\mu s, T_{vj} = 150^\circ C$	I_{sc}	59		A
Thermal resistance, junction to case	per IGBT	R_{thJC}	1.25	1.40	K/W
Temperature under switching conditions		$T_{vj op}$	-40	150	$^\circ C$

Diode, Inverter

Maximum Ratings

Parameter	Conditions	Symbol	Value	Unit
Repetitive peak reverse voltage	$T_{vj} = 25^\circ C$	V_{RRM}	1200	V
Continuous DC forward current		I_F	10	A
Repetitive peak forward current	$t_p = 1ms$	I_{FRM}	20	A
I^2t -value	$t_p = 10ms, \sin 180^\circ, T_{vj} = 125^\circ C$	I^2t	24	A^2s

Characteristic Values

Parameter	Conditions	Symbol	Value			Unit
			Min.	Typ.	Max.	
Forward voltage	$I_F=10A, V_{GE}=0V$ $T_{vj}=25^{\circ}C$	V_F		1.47	2.0	V
	$I_F=10A, V_{GE}=0V$ $T_{vj}=125^{\circ}C$			1.48		
	$I_F=10A, V_{GE}=0V$ $T_{vj}=150^{\circ}C$			1.69		
Peak reverse recovery current	$I_F=10A,$ $-di_F/dt=298A/\mu s(T_{vj}=150^{\circ}C)$ $V_R=600V, V_{GE}=-15V$ $T_{vj}=25^{\circ}C$	I_{RM}		15		A
	$T_{vj}=125^{\circ}C$			16		
	$T_{vj}=150^{\circ}C$			18		
Recovered charge	$I_F=10A,$ $-di_F/dt=298A/\mu s(T_{vj}=150^{\circ}C)$ $V_R=600V, V_{GE}=-15V$ $T_{vj}=25^{\circ}C$	Q_r		1.5		μC
	$T_{vj}=125^{\circ}C$			2.6		
	$T_{vj}=150^{\circ}C$			3.1		
Reverse recovered energy	$I_F=10A,$ $-di_F/dt=298A/\mu s(T_{vj}=150^{\circ}C)$ $V_R=600V, V_{GE}=-15V$ $T_{vj}=25^{\circ}C$	E_{rec}		0.50		mJ
	$T_{vj}=125^{\circ}C$			0.88		
	$T_{vj}=150^{\circ}C$			1.03		
Thermal resistance, junction to case	per diode	R_{thJC}		1.75	1.90	K/W
Temperature under switching conditions		$T_{vj op}$	-40		150	$^{\circ}C$

Diode, Rectifier

Maximum Ratings

Parameter	Conditions	Symbol	Value	Unit
Repetitive peak reverse voltage	$T_{vj}=25^{\circ}C$	V_{RRM}	1600	V
Non-Repetitive peak reverse voltage	$T_{vj}=25^{\circ}C$	V_{RSM}	1800	V
Maximum Average Forward Current		$I_{F(AV)}$	16	A
Surge forward current	$t_p=10ms, \sin 180^{\circ}, T_{vj}=25^{\circ}C$	I_{FSM}	190	A
I^2t -value	$t_p=10ms, \sin 180^{\circ}, T_{vj}=125^{\circ}C$	I^2t	360	A^2s

Characteristic Values

Parameter	Conditions	Symbol	Value			Unit
			Min.	Typ.	Max.	
Forward voltage	$I_F=16A, T_j=25^{\circ}C$	V_F		0.95		V
Reverse current	$V_R=V_{RRM}$ $T_{vj}=25^{\circ}C$	I_R			5	μA

Temperature under switching conditions		$T_{vj\ op}$	-40		150	°C
--	--	--------------	-----	--	-----	----

IGBT, Brake-Chopper

Maximum Ratings

Parameter	Conditions	Symbol	Value	Unit
Collector-Emitter voltage	$T_{vj}=25^{\circ}\text{C}$	V_{CES}	1200	V
Continuous DC collector current	$T_C=100^{\circ}\text{C}, T_{vj\ max}=175^{\circ}\text{C}$	$I_{C\ nom}$	10	A
Repetitive peak collector current	$t_p=1\ ms$	I_{CRM}	20	A
Total power dissipation	$T_C = 25^{\circ}\text{C}, T_{vj\ max} = 175^{\circ}\text{C}$	P_{tot}	105	W
Gate emitter voltage		V_{GE}	± 20	V

Characteristic Values

Parameter	Conditions	Symbol	Value			Unit
			Min.	Typ.	Max.	
Collector-Emitter saturation voltage	$V_{GE}=15\text{V}, I_C=10\text{A}$ $V_{GE}=15\text{V}, I_C=10\text{A}$ $V_{GE}=15\text{V}, I_C=10\text{A}$	$T_{vj}=25^{\circ}\text{C}$ $T_{vj}=125^{\circ}\text{C}$ $T_{vj}=150^{\circ}\text{C}$	V_{Cesat}	1.68 1.88 1.92	2.10	V
Gate-Emitter threshold voltage	$I_C=0.30\text{mA}, V_{GE}=V_{CE}$	$T_{vj}=25^{\circ}\text{C}$	$V_{GE(th)}$	5.65		
Gate charge	$V_{GE}=-15\text{V}\dots+15\text{V}$		Q_G	0.11		μC
Internal gate resistor			R_{Gint}	None		Ω
Input capacitance	$f=1\text{MHz}, V_{CE}=25\text{V}, V_{GE}=0\text{V}$	$T_{vj}=25^{\circ}\text{C}$	C_{ies}	0.86		nF
Reverse transfer capacitance			C_{res}	0.02		
Collector-emitter cut-off current	$V_{CE}=1200\text{V}, V_{GE}=0\text{V}$	$T_{vj}=25^{\circ}\text{C}$	I_{CES}		1	mA
Gate-emitter leakage current	$V_{CE}=0\text{V}, V_{GE}=20\text{V}$	$T_{vj}=25^{\circ}\text{C}$	I_{GES}		100	nA
Turn-on delay time	$I_C=10\text{A}, V_{CE}=600\text{V}$ $V_{GE}=\pm 15\text{V}, R_G=40\Omega$ (inductive load)	$T_{vj}=25^{\circ}\text{C}$ $T_{vj}=125^{\circ}\text{C}$ $T_{vj}=150^{\circ}\text{C}$	$t_{d\ on}$	49 47 43		ns
Rise time	$I_C=10\text{A}, V_{CE}=600\text{V}$ $V_{GE}=\pm 15\text{V}, R_G=40\Omega$ (inductive load)	$T_{vj}=25^{\circ}\text{C}$ $T_{vj}=125^{\circ}\text{C}$ $T_{vj}=150^{\circ}\text{C}$	t_r	38 39 40		
Turn-off delay time	$I_C=10\text{A}, V_{CE}=600\text{V}$ $V_{GE}=\pm 15\text{V}, R_G=40\Omega$ (inductive load)	$T_{vj}=25^{\circ}\text{C}$ $T_{vj}=125^{\circ}\text{C}$ $T_{vj}=150^{\circ}\text{C}$	$t_{d\ off}$	239 283 295		

Fall time	$I_C=10A, V_{CE}=600V$ $V_{GE}=\pm 15V, R_G=40\Omega$ (inductive load)	$T_{vj}=25^\circ C$ $T_{vj}=125^\circ C$ $T_{vj}=150^\circ C$	t_f		162 259 241		
Turn-on energy loss per pulse	$I_C=10A, V_{CE}=600V$ $V_{GE}=\pm 15V, R_G=40\Omega$ (inductive load)	$T_{vj}=25^\circ C$ $T_{vj}=125^\circ C$ $T_{vj}=150^\circ C$	E_{on}		0.62 0.81 0.87		mJ
Turn-off energy loss per pulse	$I_C=10A, V_{CE}=600V$ $V_{GE}=\pm 15V, R_G=40\Omega$ (inductive load)	$T_{vj}=25^\circ C$ $T_{vj}=125^\circ C$ $T_{vj}=150^\circ C$	E_{off}		0.68 0.88 0.93		
Thermal resistance, junction to case	per IGBT		R_{thJC}		1.25	1.40	K/W
Temperature under switching conditions			$T_{vj op}$	-40		150	$^\circ C$

Diode, Brake-Chopper

Maximum Ratings

Parameter	Conditions	Symbol	Value	Unit
Repetitive peak reverse voltage	$T_{vj}=25^\circ C$	V_{RRM}	1200	V
Continuous DC forward current		I_F	8	A
Repetitive peak forward current	$t_p=1ms$	I_{FRM}	16	A
I^2t -value	$V_R=0V, t_p=10ms, T_{vj}=125^\circ C$	I^2t	24	A^2t

Characteristic Values

Parameter	Conditions	Symbol	Value			Unit	
			Min.	Typ.	Max.		
Forward voltage	$I_F=8A, V_{GE}=0V$ $I_F=8A, V_{GE}=0V$ $I_F=8A, V_{GE}=0V$	V_F		1.88 1.96 1.90	2.3	V	
Peak reverse recovery current	$I_F=8A,$ $-di_F/dt=203A/\mu s(T_{vj}=150^\circ C)$ $V_R=600V, V_{GE}=-15V$	I_{RM}		6 7 8		A	
Recovered charge	$I_F=8A,$ $-di_F/dt=203A/\mu s(T_{vj}=150^\circ C)$ $V_R=600V, V_{GE}=-15V$	Q_F		0.8 1.2 1.3		μC	
Reverse recovered energy	$I_F=8A,$ $-di_F/dt=203A/\mu s(T_{vj}=150^\circ C)$ $V_R=600V, V_{GE}=-15V$	E_{rec}		0.27 0.49 0.53		mJ	
Thermal resistance, junction to case	per diode	R_{thJC}		1.75	1.90	K/W	
Temperature under switching conditions			$T_{vj op}$	-40		150	$^\circ C$

NTC-Thermistor

Characteristic Values

Parameter	Conditions	Symbol	Value			Unit
			Min.	Typ.	Max.	
Rated resistances	$T_C=25^{\circ}\text{C}$, $\pm 5\%$	R_{25}		5.0		$\text{k}\Omega$
B-value	$\pm 1\%$	$B_{25/50}$		3380		K

Module

Parameter	Conditions	Symbol	Value			Unit
Isolation test voltage	RMS, $f=50\text{Hz}$, $t=1\text{min}$	V_{ISOL}	2500			V
Internal isolation			Al_2O_3			
Storage temperature		T_{stg}	-40		125	$^{\circ}\text{C}$
Mounting torque for modul mounting		M	3.0		6.0	Nm
Weight		W		23		g

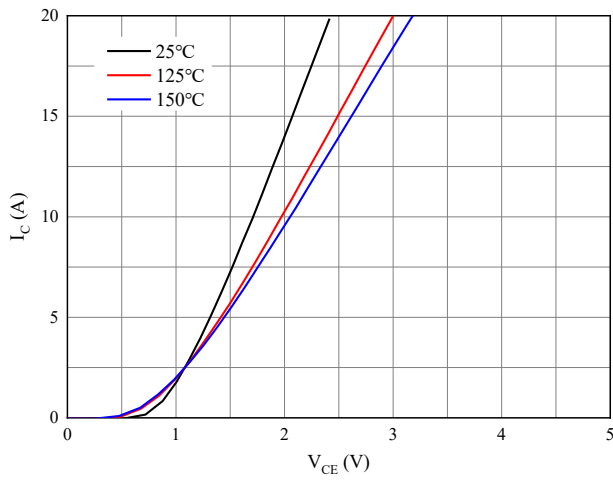

Fig 1. Typical output characteristics ($V_{GE}=15V$)

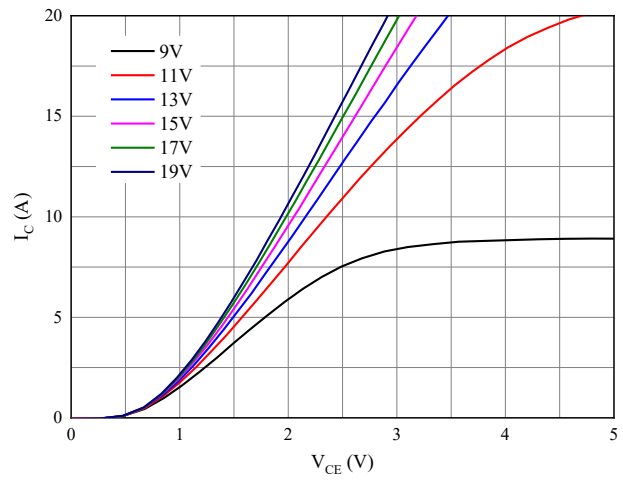

Fig 2. Typical output characteristics ($T_{vj}=150^{\circ}C$)

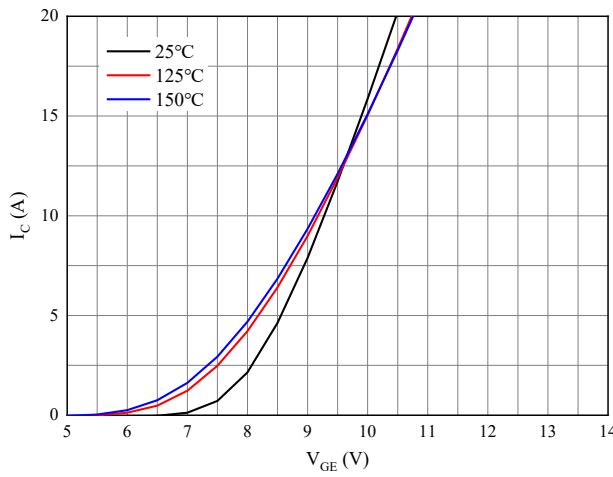

Fig 3. Typical transfer characteristic ($V_{CE}=20V$)

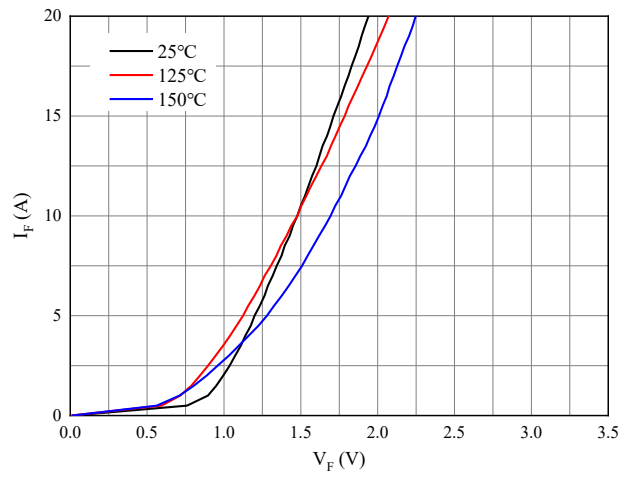

Fig 4. Forward characteristic of Diode

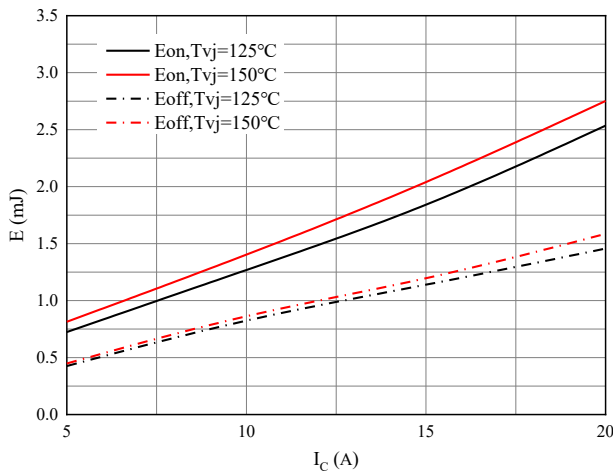

Fig 5. Switching losses of IGBT

$V_{GE}=\pm 15V, R_{Gon}=40\Omega, R_{Goff}=40\Omega, V_{CE}=600V$

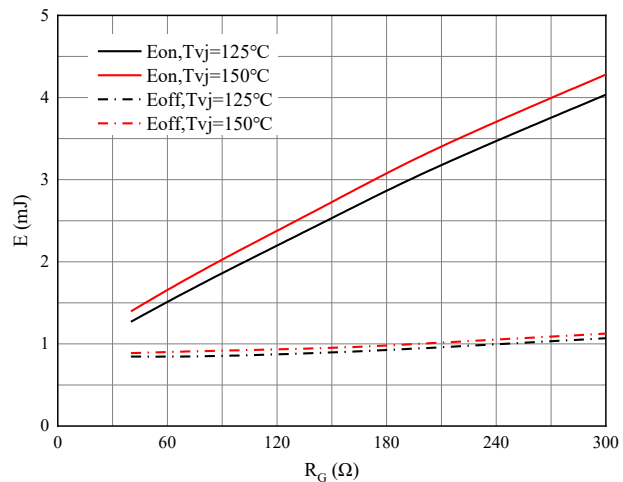

Fig 6. Switching losses of IGBT

$V_{GE}=\pm 15V, I_C=10A, V_{CE}=600V$

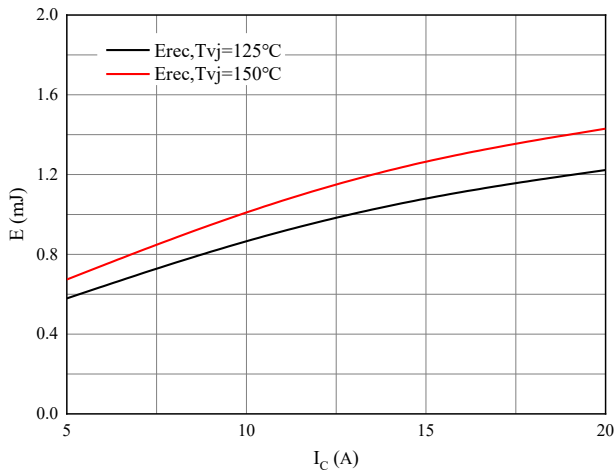

Fig 7. Switching losses of Diode
 $R_{Gon}=40\Omega, V_{CE}=600V$

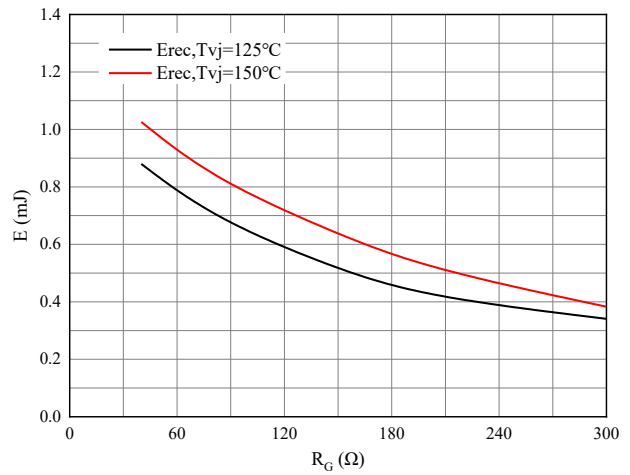

Fig 8. Switching losses of Diode
 $I_F=10A, V_{CE}=600V$

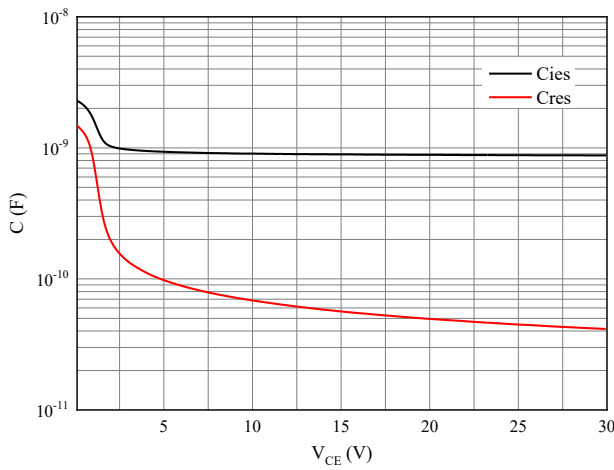

Fig 9. Capacitance characteristic

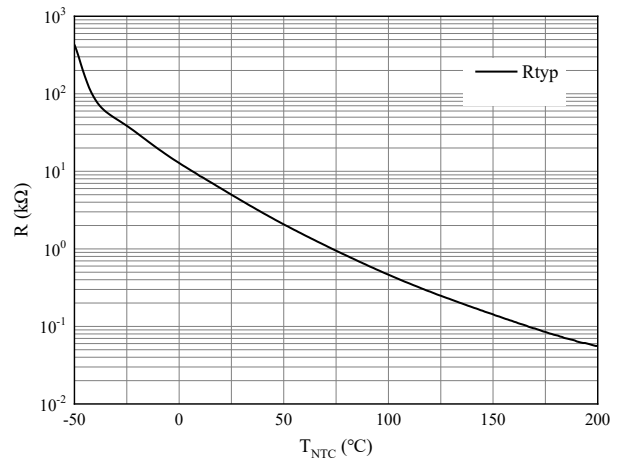
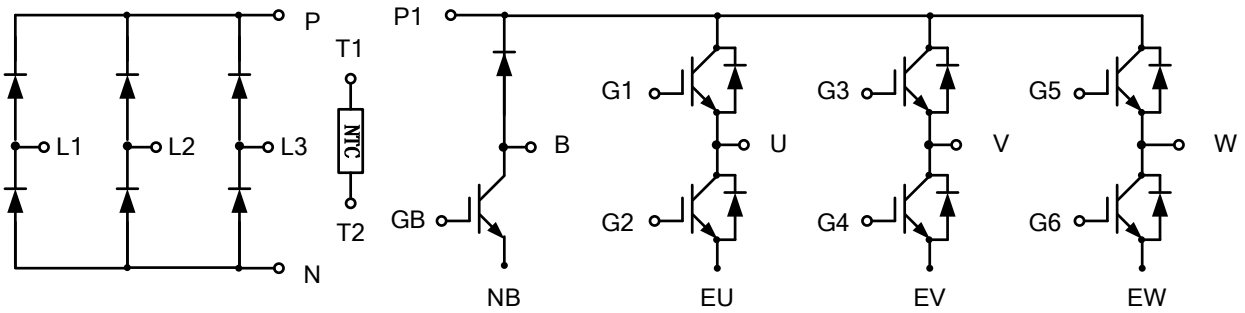

Fig 10. NTC-Themistor-temperature characteristic

Circuit diagram



Package outlines

