

NPT & Rugged Type 1200V IGBT Module

Description

The IGBT Module D3 package devices are optimized to reduce losses and switching noise in high frequency power conditioning electrical systems.

These IGBT Module series are ideally suited for IH ,High Power inverters, Motors drives and other applications where switching losses are significant portion of the total losses.

Features

- $V_{CES}=1200V$
- Low Conduction Loss: $V_{CE(sat)} = 3.2 V @ I_C=100A$
- Fast & Soft Anti-Parallel FWD
- Short Circuit rated:10us at $T_C=100^\circ C$
- Isolation Type Package

Applications

- Induction Heating, Motor Drives, High Power Inverters
- Welding Machine, UPS

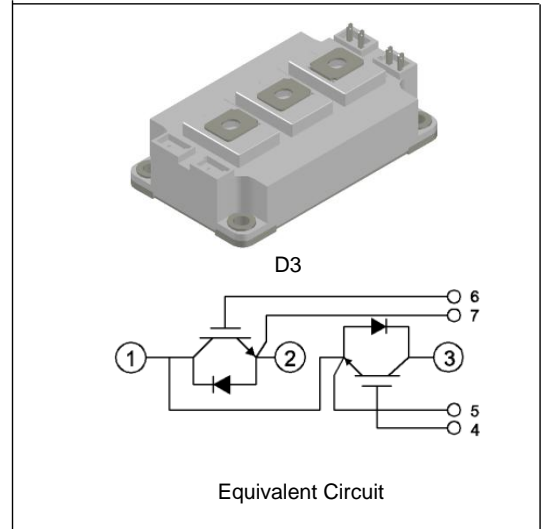

Absolute Maximum Ratings (at $T_C=25^\circ C$ unless otherwise noted)

Symbol	Parameter	Conditions	Ratings	Unit
V_{CES}	Collector to Emitter Voltage		1200	V
V_{GES}	Gate to Emitter Voltage		± 20	V
I_C	Collector Current	$T_C=25^\circ C$	175	A
		$T_C=100^\circ C$	100	A
I_{CM}	Pulsed Collector Current , $t_p=1ms$		200	A
I_F	Diode Continuous Forward Current	$T_C=100^\circ C$	75	A
I_{FM}	Diode Maximum Forward Current		150	A
P_D	Maximum Power Dissipation	$T_C=25^\circ C$	650	W
T_J	Operating Junction Temperature Range		-55~+150	$^\circ C$
T_{STG}	Storage Temperature Range		-55~+125	$^\circ C$
V_{iso}	Isolation Voltage	AC 1minute	2500	V
	Mounting screw Torque: M6		4	N.M
	Weight		300	g

Thermal Characteristics

Symbol	Parameter	Ratings	Unit
$R_{th(J-C)}$ (IGBT)	Thermal Resistance, Junction to case for IGBT	0.11	$^\circ C/W$
$R_{th(J-C)}$ (Diode)	Thermal Resistance, Junction to case for Diode	0.2	$^\circ C/W$
$R_{th(C-A)}$	Thermal Resistance, Case to Ambient	0.05	$^\circ C/W$

Electrical Characteristics of IGBT @ $T_C=25\text{ }^\circ\text{C}$ unless otherwise noted

Symbol	Parameter	Conditions	Min.	Typ.	Max.	Unit
BV_{CES}	Collector to Emitter Breakdown Voltage	$V_{GE}=0V, I_C=1mA$	1220	-	-	V
$V_{CE(sat)}$	Collector to Emitter Saturation Voltage	$I_C=100A, V_{GE}=15V$	-	3.2	3.8	V
		$I_C=100A, V_{GE}=15V, T_C=100^\circ\text{C}$	-	3.9	-	V
$V_{GE(th)}$	Gate Threshold Voltage	$V_{CE}=V_{GE}, I_C=2mA$	4.5	-	7.5	V
I_{CES}	Zero Gate Voltage Collector Current	$V_{CE}=V_{CES}, V_{GE}=0V$	-	-	2	mA
I_{GES}	Gate to Emitter Leakage Current	$V_{GE}=V_{GES}, V_{CE}=0V$	-	-	± 300	nA

Electrical Characteristics of Diode @ $T_C=25\text{ }^\circ\text{C}$ unless otherwise noted

Symbol	Parameter	Conditions	Min.	Typ.	Max.	Unit
V_F	Diode Forward Voltage	$I_F=75A$	-	2.0	3.6	V
		$I_F=75A, T_C=100^\circ\text{C}$	-	1.8	-	V
t_{rr}	Diode Reverse Recovery Time	$I_F=75A, di/dt=-200A/\mu s$	-	160	-	ns
I_{rr}	Diode Peak Reverse Recovery Current		-	16	-	A
Q_{rr}	Diode Reverse Recovery Charge		-	1400	-	nC
t_{rr}	Diode Reverse Recovery Time	$I_F=75A, di/dt=-200A/\mu s, T_C=100^\circ\text{C}$	-	310	-	ns
I_{rr}	Diode Peak Reverse Recovery Current		-	28	-	A
Q_{rr}	Diode Reverse Recovery Charge		-	9050	-	nC

Switching Characteristics @ $T_C=25\text{ }^\circ\text{C}$ unless otherwise noted

Symbol	Parameter	Conditions	Min.	Typ.	Max.	Unit	
$t_{d(on)}$	Turn-on Delay Time	$I_C=100A, V_{CC}=600V, V_{GE}=\pm 15V, R_G=10\Omega, \text{Inductive Load}$	-	100	-	ns	
t_r	Turn-on Rise Time		-	75	-	ns	
$t_{d(off)}$	Turn-off Delay Time		-	420	-	ns	
t_f	Turn-off Fall Time		-	60	-	ns	
E_{on}	Turn-on Switching Loss		-	7	-	mJ	
E_{off}	Turn-off Switching Loss		-	9.5	-	mJ	
E_{ts}	Total Switching Loss		-	16.5	-	mJ	
C_{ies}	Input Capacitance		$V_{GE}=0V, V_{CE}=30V, f=1.0MHz$	-	4760	-	pF
C_{res}	Reverse Transfer Capacitance			-	518	-	pF
C_{oes}	Output Capacitance	-		175	-	pF	
Q_g	Total Gate Charge	$I_C=100A, V_{CC}=600V, V_{GE}=\pm 15V$	-	400	-	nC	
Q_{ge}	Gate to Emitter Charge		-	44	-	nC	
Q_{gc}	Gate to Collector Charge		-	236	-	nC	
t_{sc}	Short Circuit Withstand Time	$V_{CC}=600V, V_{GE}=\pm 15V, R_G=10\Omega @T_C=100^\circ\text{C}$	10	-	-	us	

Typical Performance Characteristics

Fig. 1. Typical Output Characteristics

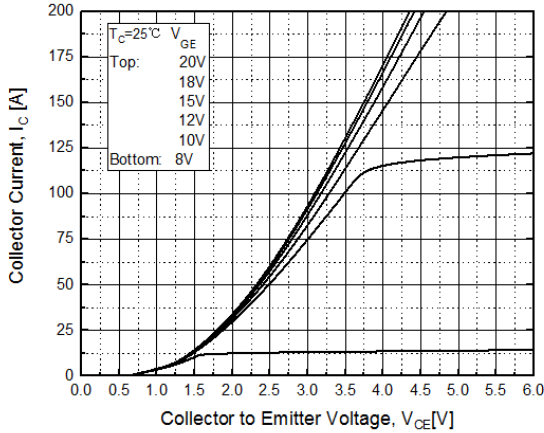

Fig. 2. Typical Output Characteristics

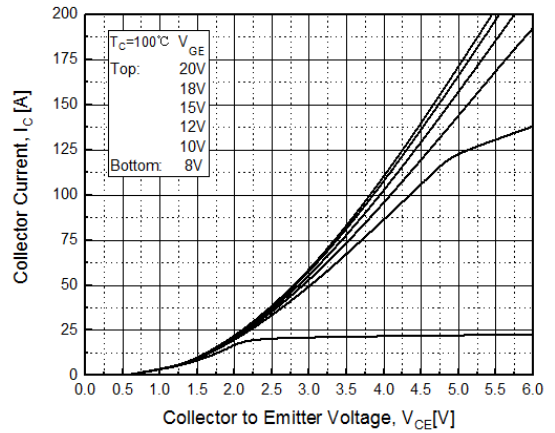

Fig. 3. Typical Saturation Voltage Characteristics

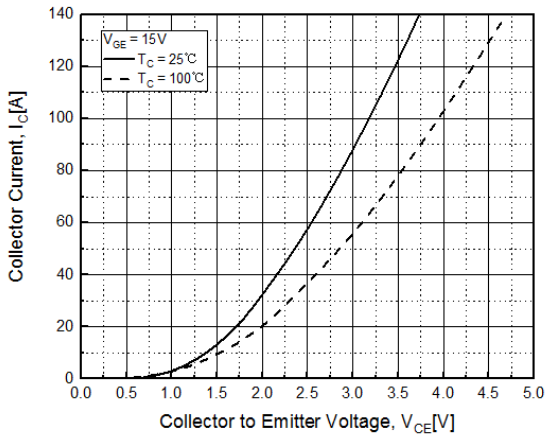

Fig. 4. Gate Charge Characteristics

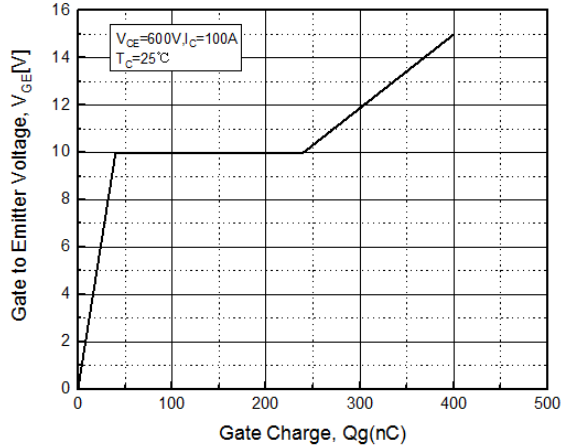

Fig. 5. Turn-on Characteristics vs. R_G

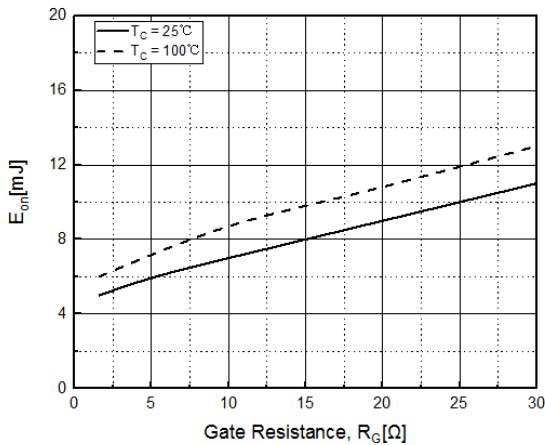
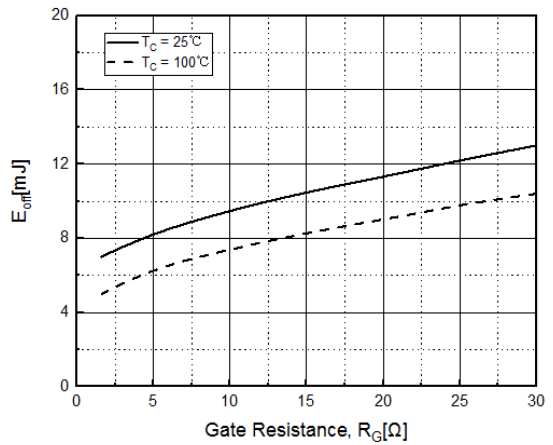

Fig. 6. Turn-off Characteristics vs. R_G



Typical Performance Characteristics

Fig. 7. Rate Current vs. T_C

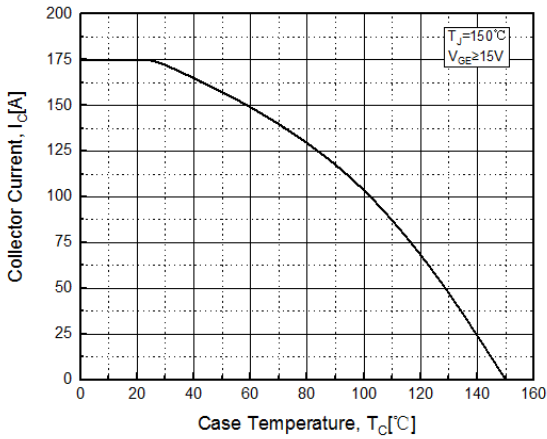

Fig. 8. Power Dissipation vs. T_C

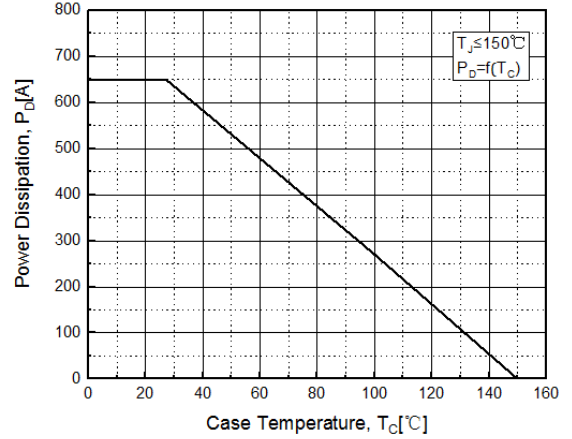

Fig. 9. Transient Thermal Impedance

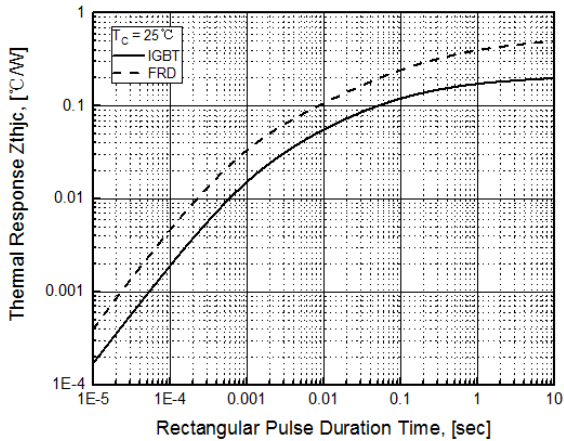
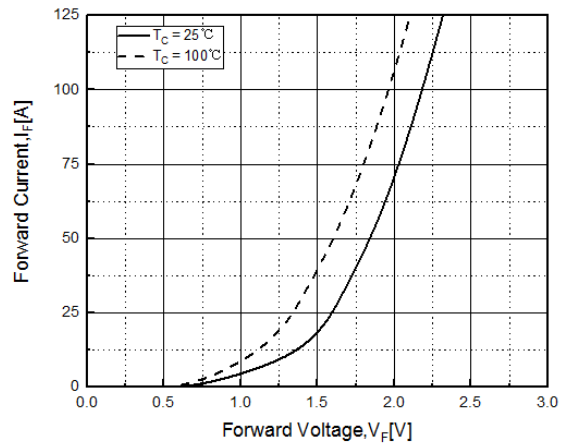
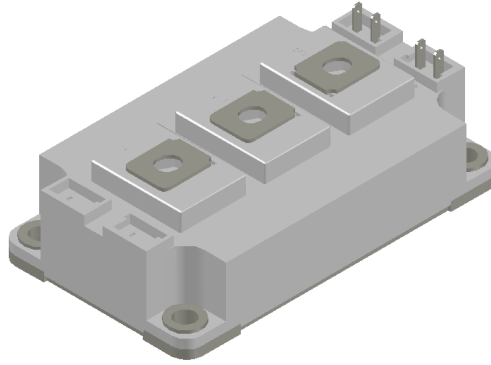

Fig. 10. Forward Characteristics



Package Dimensions

D3



(Dimensions in Millimeters)

