

Diode Module

Description

- 1) A package of series of two diodes.
- 2) With high thermal conductivity DBC as the insulation.
- 3) Welding by vacuum welding technology, which provide high reliability.

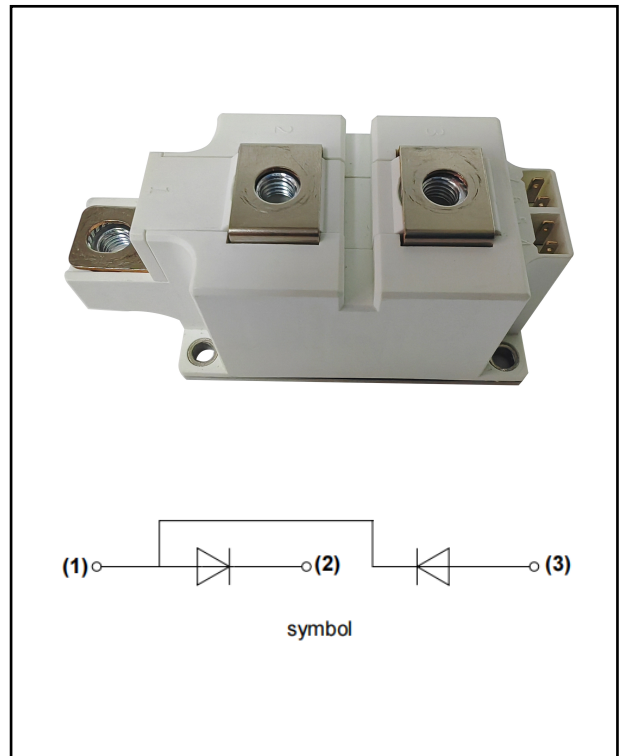

Typical Application

AC converter, inverter and DC motor.

Absolute Maximum Ratings (Packaged into modules, unless otherwise specified, $T_{CASE}=25^{\circ}C$)

Parameter	Test Conditions	Symbol	Values				Unit
			12	16	18	20	
Operating junction temperature range		T_j	-40-150				$^{\circ}C$
Storage temperature range		T_{stg}	-40-125				$^{\circ}C$
Repetitive peak reverse voltage	$T_j=25^{\circ}C$	V_{RRM}	1200	1600	1800	2000	V
Non-repetitive peak reverse voltage	$T_j=25^{\circ}C$	V_{RSM}	1300	1700	1900	2100	V
Average forward current	$T_c=100^{\circ}C$	$I_{F(AV)}$	300				A
Peak forward surge current	$t_p=10ms, \sin 180^{\circ}$,	I_{FSM}	8400				A
I^2t value for fusing	$T_j=25^{\circ}C$	I^2t	352800				A^2s
Insulation voltage	A.C 50Hz(1s/1min)	V_{ISO}	3600/3000				V

Electrical Characteristics (Packaged into modules, unless otherwise specified, $T_{CASE}=25^{\circ}C$)

Parameter	Test Conditions	Symbol	Values	Unit
Peak forward voltage	$I_F=900A$, $t_P=380\mu s$	V_{FM}	≤ 1.6	V
Threshold voltage	$T_j=150^{\circ}C$	V_{TO}	≤ 0.81	V
Dynamic resistance	$T_j=150^{\circ}C$	R_d	≤ 0.9	m Ω
Repetitive peak reverse current	$V_R=V_{RRM}$ $T_j=25^{\circ}C$	I_{RRM1}	≤ 100	μA
	$T_j=150^{\circ}C$	I_{RRM2}	≤ 90	mA
Thermal resistance(Per chip)	Junction to case	$R_{th(j-c)}$	0.13	$^{\circ}C/W$
	Case to heatsink	$R_{th(c-s)}$	0.05	

Performance Curves

FIG.1: Forward characteristics(per diode)

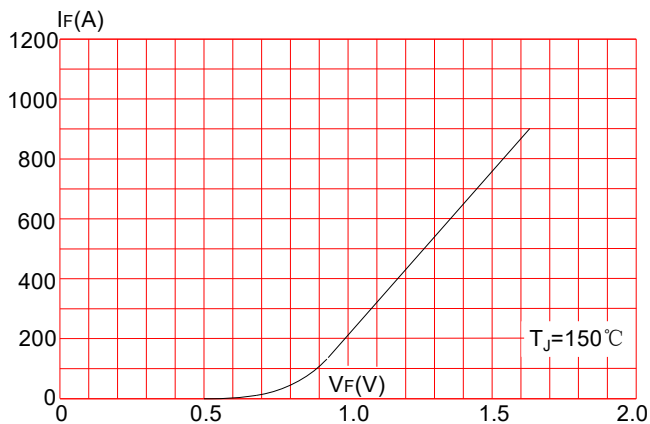

FIG.2: Peak on-state surge current

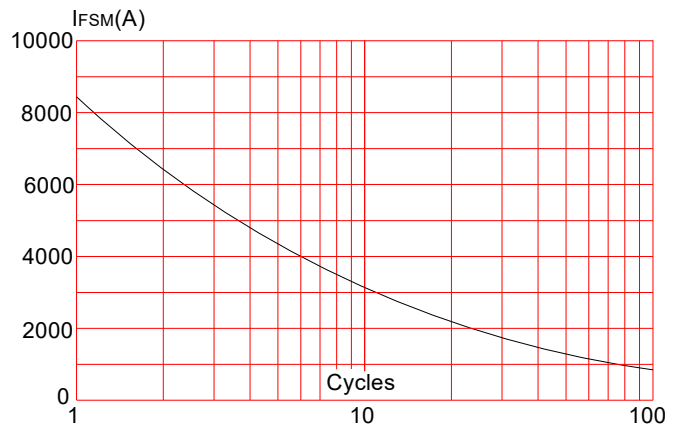

FIG.3: Forward current vs. case temperature

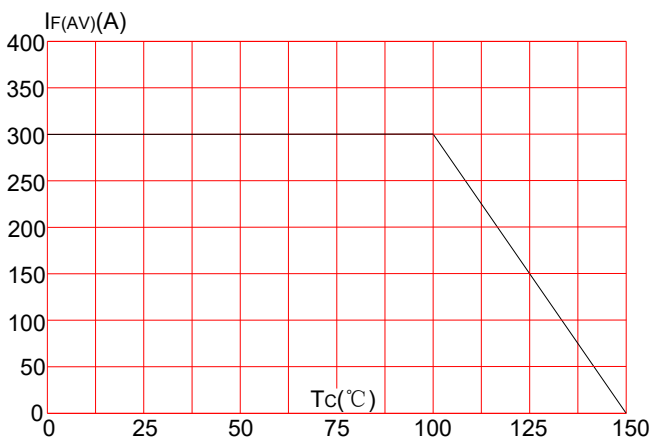
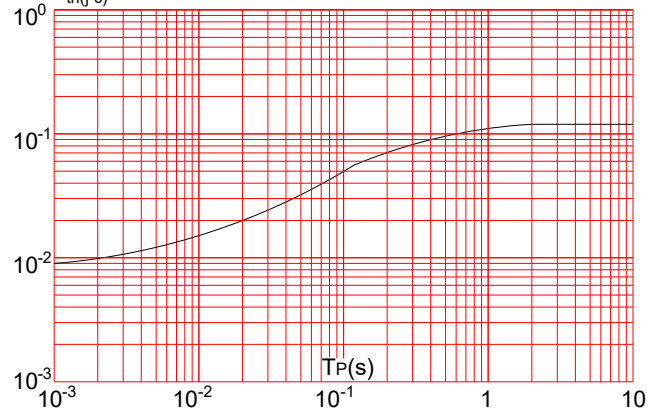
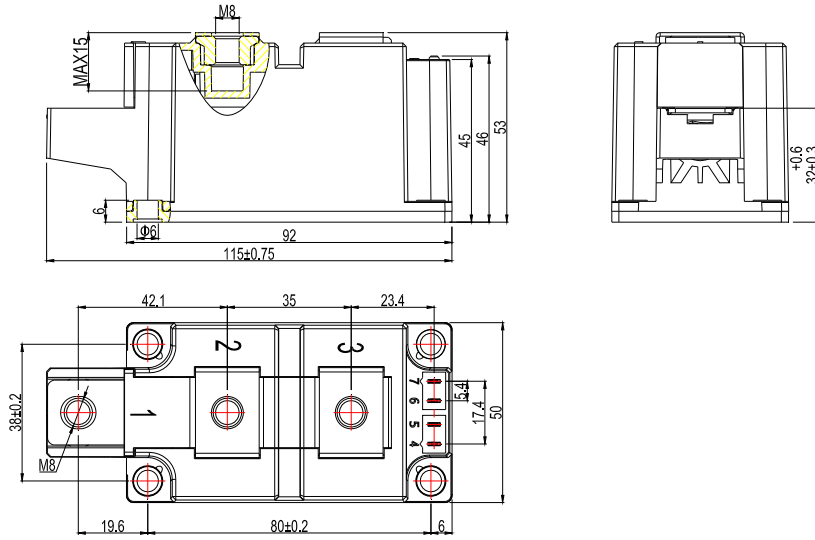

FIG.4: Maximum transient thermal impedance $R_{th(j-c)}$ (K/W) Junction-to-case(per diode)



Mechanical Characteristics

Module size	115mm×50mm
Module height	53mm
Terminal distance of (1)/(2)/(3)	42.1mm/35mm/23.4mm
Mounting torque(M5)	5±15%Nm
Terminal torque(M8)	9±15%Nm



T3

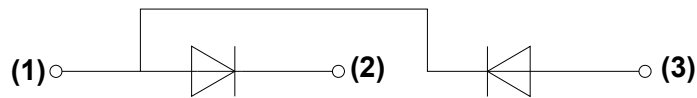

symbol