

Description

- 1) A package of series of two chips.
- 2) With high thermal conductivity DBC as the insulation.
- 3) Welding by vacuum welding technology, which provide high reliability.

Typical Application

DC motor control, temperature control and light control system.



Absolute Maximum Ratings (Packaged into modules, unless otherwise specified, $T_{CASE}=25^{\circ}C$)

Parameter	Test Conditions	Symbol	Values			Unit
			12	16	18	
Operating junction temperature range		T_j	-40-125			$^{\circ}C$
Storage temperature range		T_{stg}	-40-125			$^{\circ}C$
Repetitive peak off-state voltage	$T_j=25^{\circ}C$	V_{DRM}	1200	1600	1800	V
Repetitive peak reverse voltage	$T_j=25^{\circ}C$	V_{RRM}	1200	1600	1800	V
Non-repetitive peak off-state voltage	$T_j=25^{\circ}C$	V_{DSM}	1300	1700	1900	V
Non-repetitive peak reverse voltage	$T_j=25^{\circ}C$	V_{RSM}	1300	1700	1900	V
Average on-state current	$T_C=85^{\circ}C$	$I_{T(AV)}/I_{F(AV)}$	120			A
Peak on-state surge current	$t_p=10ms$ $V_R=0.6V_{RRM}$	I_{TSM}/I_{FSM}	2500			A
I^2t value for fusing	$t_p=10ms$ $V_R=0.6V_{RRM}$	I^2t	31250			A^2s
Critical rate of rise of on-state current	$I_G=2 \times I_{GT}$	di/dt	150			$A/\mu s$
Isolation voltage	A.C 50Hz(1s/1min)	V_{ISO}	3600/3000			V

Electrical Characteristics (Packaged into modules, unless otherwise specified, $T_{CASE}=25^{\circ}C$)

Parameter	Test Conditions	Symbol	Values	Unit
Peak on-state voltage	$I_T=360A$ $t_P=380\mu s$	V_{TM}	≤ 1.8	V
Threshold voltage	$T_J=125^{\circ}C$	V_{TO}	≤ 0.95	V
Dynamic resistance	$T_J=125^{\circ}C$	R_d	≤ 2.1	m Ω
Repetitive peak off-state current	$V_D=V_{DRM}$ $T_C=25^{\circ}C$	I_{DRM1}	≤ 100	μA
	$T_C=125^{\circ}C$	I_{DRM2}	≤ 40	mA
Repetitive peak reverse current	$V_R=V_{RRM}$ $T_C=25^{\circ}C$	I_{RRM1}	≤ 100	μA
	$T_C=125^{\circ}C$	I_{RRM2}	≤ 40	mA
Triggering gate current	$V_D=12V$ $R_L=30\Omega$	I_{GT}	20-120	mA
Holding current	$I_T=1A$	I_H	≤ 250	mA
Latching current	$I_G=1.2 I_{GT}$	I_L	≤ 300	mA
Triggering gate voltage	$V_D=12V$ $R_L=30\Omega$	V_{GT}	≤ 1.8	V
Non triggering gate voltage	$V_D=V_{DRM}$ $T_J=125^{\circ}C$	V_{GD}	≥ 0.25	V
Critical rate of rise of voltage	$V_D=2/3V_{DRM}$ $T_J=125^{\circ}C$ Gate Open	dv/dt	≥ 1000	V/ μs
Thermal resistance	Junction to case	$R_{th(j-c)}$	0.29	$^{\circ}C/W$
	Case to heatsink	$R_{th(c-s)}$	0.21	

Mechanical Characteristics

Module size	93mm×21mm
Module height	30mm
Terminal distance of (1)/(2)/(3)	20mm
Mounting torque(M5)	5±15%Nm
Terminal torque(M5)	3±15%Nm

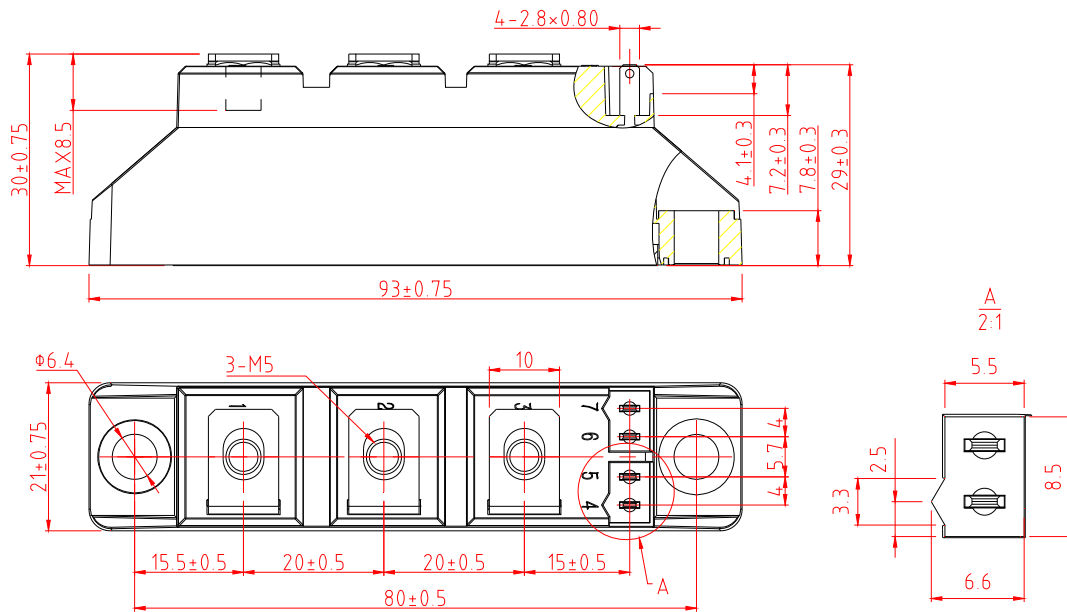

T1

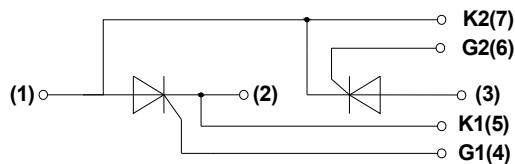

AKMD symbol

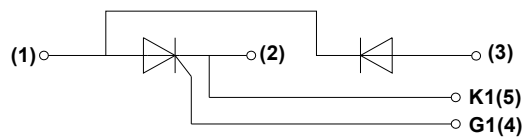

AKMH symbol

Performance Curves

FIG.1: Power dissipation vs. on-state current (per thyristor or diode)

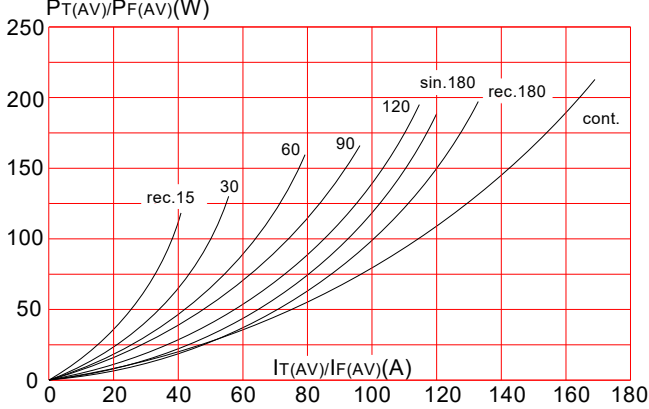

FIG.2: Maximum transient thermal impedance junction to case(per thyristor or diode)

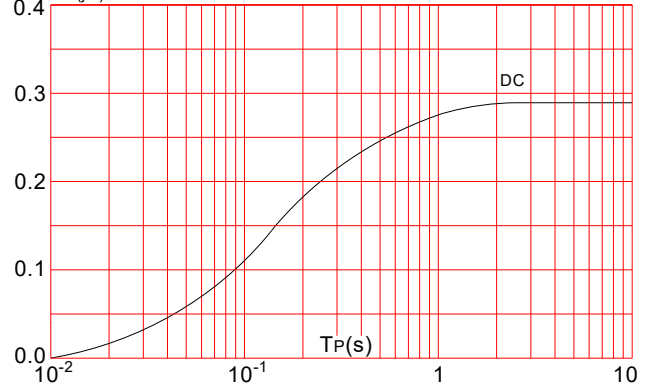

FIG.3: Forward characteristics (per thyristor or diode)

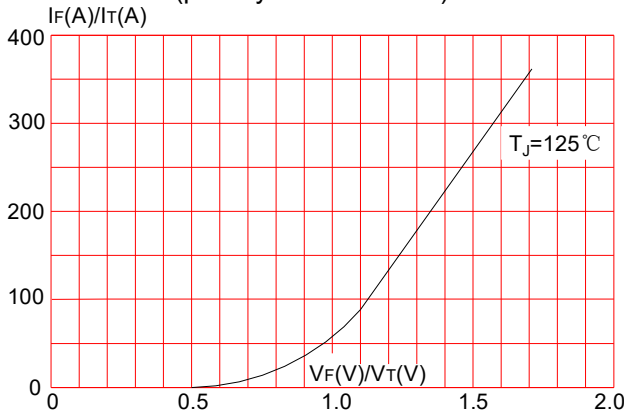
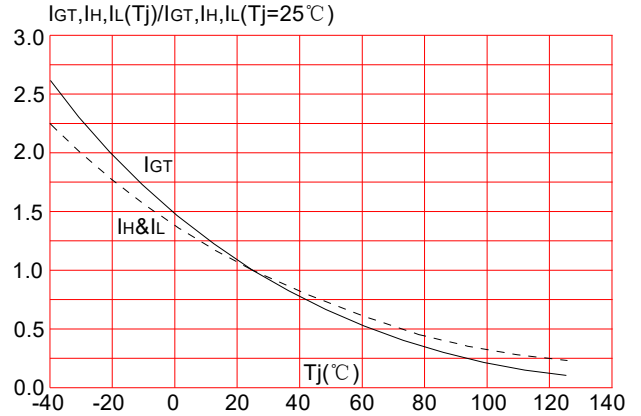

FIG.4: Relative variations of gate trigger current, holding current and latching current versus junction temperature



Ordering Information

AK

MD

125

/

16

Aiko Electronics Technology Co., LTD

MD: Thyristor module

MH: Thyristor and diode module

$I_T(AV)/I_F(AV)=120A$

12: $V_{DSM}/V_{RSM} \geq 1300V$

16: $V_{DSM}/V_{RSM} \geq 1700V$

18: $V_{DSM}/V_{RSM} \geq 1900V$