

## 1200V 70mΩ N-Channel SiC Power MOSFET

### Description

The AKCT70N120HB 120B is a high blocking voltage N-Channel SiC power MOSFET. This device provide excellent performance for high voltage power supplies or pulse circuits.

### Features

- Typical on-Resistance:  $R_{DS(on)}=70m\Omega$ (typ.)
- High Blocking Voltage
- 100% Avalanche Test
- Good Stability and Uniformity with High  $E_{AS}$

### Applications

- Solar Inverters
- High Voltage DC/DC Converters
- Motor Drivers
- Switch Mode Power Supplies

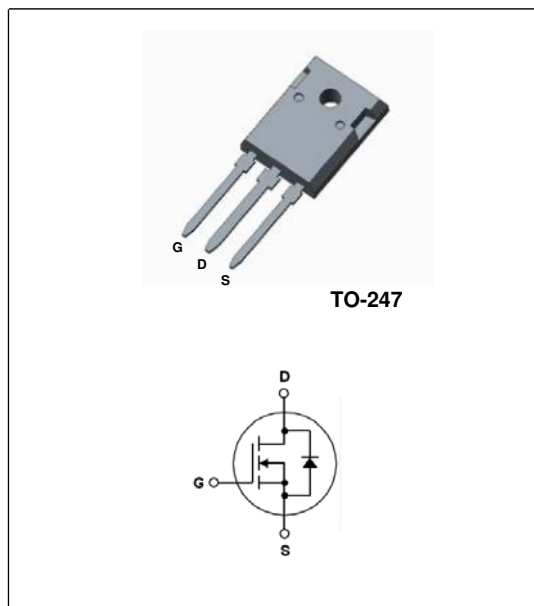

### Absolute Maximum Ratings @ $T_C=25\text{ }^\circ\text{C}$ unless otherwise noted

Symbol	Parameter	Ratings	Unit	
$V_{DSS}$	Drain to Source Voltage	1200	V	
$V_{GSS}$	Gate to Source Voltage	-10/+25	V	
$V_{GSop}$	Recommended operation Values of Gate -Source Voltage	-5/+20	V	
$I_D$	Drain Current	$T_C=25\text{ }^\circ\text{C}$	40	A
		$T_C=100\text{ }^\circ\text{C}$	25	A
$I_{DM}$	Pulsed Drain Current (Note1)	80	A	
$P_D$	Maximum Power Dissipation	$T_C=25\text{ }^\circ\text{C}$	300	W
	Derate above 25 $^\circ\text{C}$		2.86	W/ $^\circ\text{C}$
$E_{AS}$	Single Pulsed Avalanche Energy (Note 2)	800	mJ	
$T_J$	Operating Junction Temperature Range	-40~+175	$^\circ\text{C}$	
$T_{STG}$	Storage Temperature Range	-40~+175	$^\circ\text{C}$	

### Thermal Characteristics

Symbol	Parameter	Ratings	Unit
$R_{th(J-C)}$	Thermal Resistance, Junction to case	0.5	$^\circ\text{C}/\text{W}$
$R_{th(J-A)}$	Thermal Resistance, Junction to Ambient	40	$^\circ\text{C}/\text{W}$

## Electrical Characteristics @T<sub>C</sub>=25 °C unless otherwise noted

Symbol	Parameter	Conditions	Min.	Typ.	Max.	Unit
BV <sub>DSS</sub>	Drain to Source Breakdown Voltage	V <sub>GS</sub> =0V, I <sub>D</sub> =100uA	1200	-	-	V
V <sub>GS(th)</sub>	Gate Threshold Voltage	V <sub>DS</sub> =V <sub>GS</sub> , I <sub>D</sub> =15mA	2	2.5	4.2	V
R <sub>DS(on)</sub>	Static Drain-Source On-Resistance	V <sub>GS</sub> =20V, I <sub>D</sub> =20A	-	70	80	mΩ
I <sub>DSS</sub>	Zero Gate Voltage Drain Current	V <sub>DS</sub> =V <sub>DSS</sub> , V <sub>GS</sub> =0V	-	-	100	uA
I <sub>GSS</sub>	Gate to Source Leakage Current	V <sub>GS</sub> =V <sub>GSS</sub> , V <sub>DS</sub> =0V	-	-	±500	nA

## D-S Diode Characteristics and Maximum Rating @T<sub>C</sub>=25 °C unless otherwise noted

Symbol	Parameter	Conditions	Min.	Typ.	Max.	Unit
V <sub>SD</sub>	Drain-Source Diode Forward Voltage	V <sub>GS</sub> =0V, I <sub>S</sub> =10A	-	3.1	-	V
t <sub>rr</sub>	Reverse Recovery Time	V <sub>GS</sub> =0V, I <sub>S</sub> =20A, di/dt=-1000A/us	-	30	-	ns
Q <sub>rr</sub>	Reverse Recovery Charge		-	70	-	nC

## Switching Characteristics @T<sub>C</sub>=25 °C unless otherwise noted

Symbol	Parameter	Conditions	Min.	Typ.	Max.	Unit
t <sub>d(on)</sub>	Turn-on Delay Time	I <sub>D</sub> =20A , V <sub>DD</sub> =800V, R <sub>G</sub> =2.5Ω V <sub>GS</sub> = -5/20V, (Note 3)	-	26	-	ns
t <sub>r</sub>	Turn-on Rise Time		-	22	-	ns
t <sub>d(off)</sub>	Turn-off Delay Time		-	50	-	ns
t <sub>f</sub>	Turn-off Fall Time		-	39	-	ns
C <sub>iss</sub>	Input Capacitance	V <sub>GS</sub> =0V, V <sub>DS</sub> =800V, f=1.0MHz	-	1250	-	pF
C <sub>oss</sub>	Output Capacitance		-	70	-	pF
C <sub>rss</sub>	Reverse Transfer Capacitance		-	10.2	-	pF
Q <sub>g</sub>	Total Gate Charge	I <sub>D</sub> =20A, V <sub>DD</sub> =800V V <sub>GS</sub> =-5V/20V (Note 3)	-	75	-	nC
Q <sub>gs</sub>	Gate to Source Charge		-	25	-	nC
Q <sub>gd</sub>	Gate to Drain Charge		-	15.8	-	nC

### Note:

1. Repetitive rating: pulse-width limited by maximum junction temperature
2. V<sub>DD</sub>=100V, L=10mH, V<sub>clamp</sub>=1200V, V<sub>G</sub>=10V
3. Essentially independent of operating temperature typical characteristics

**Typical Performance Characteristics**

Fig. 1. Typical on-Resistance Characteristics

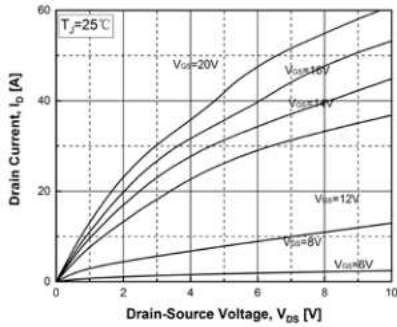

Fig. 2. On-Resistance vs. Drain Current and Gate Voltage

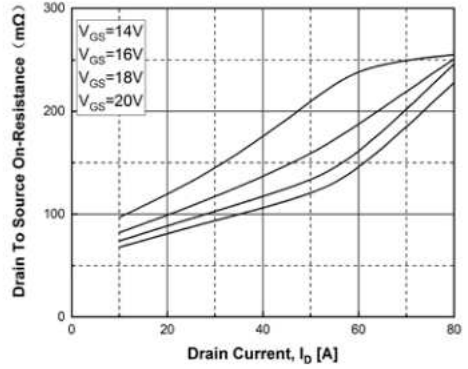

Fig. 3. Normalized On-Resistance vs. Junction Temperature

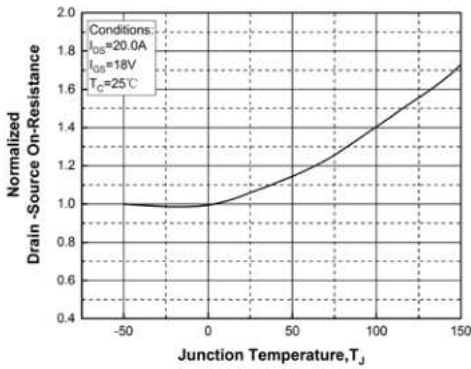

Fig. 4. On-Resistance vs. Gate-to-source Voltage

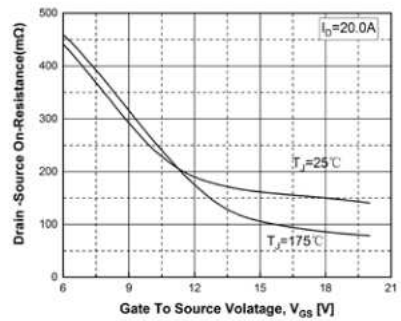

Fig. 5. Transfer Characteristics

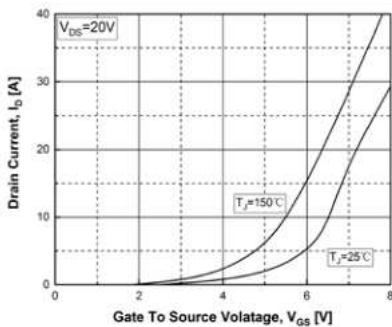
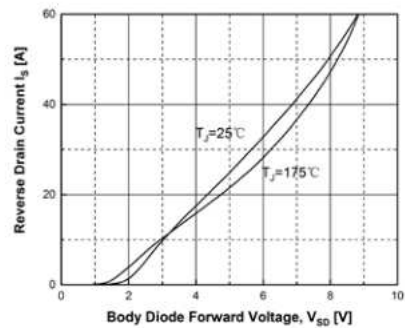

Fig. 6. Source-to-Drain Diode Forward Voltage vs. Source Current



**Typical Performance Characteristics**

Fig. 7. Gate Charge Characteristics

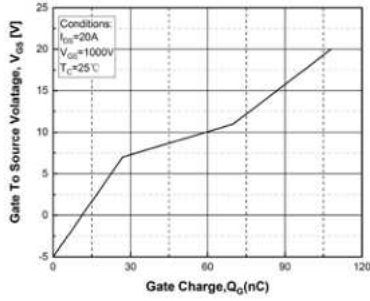

Fig. 8. Characteristics vs. Drain-to-Source Voltage

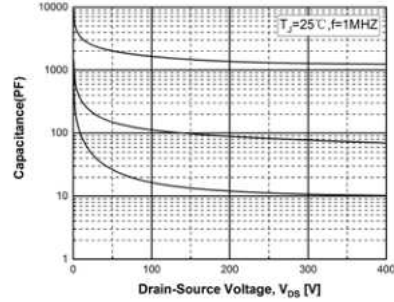
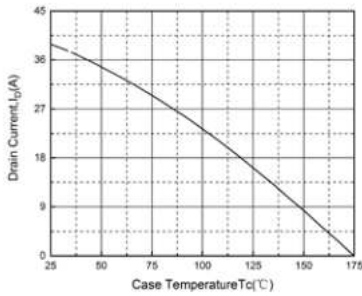

Fig. 9. Maximum Drain Current vs. Temperature



**Package Dimensions**

**TO-247**

(Dimensions in Millimeters)

