

Filed Stop & Trench Type 1200V IGBT Module

Description

The IGBT Module 12SM-3 package devices are optimized to reduce losses and switching noise in high frequency power conditioning electrical systems.

These IGBT Module series are ideally suited for High Power Converters, Motor Drivers, Induction Heating, UPS, Welding Machine where switching losses are significant portion of the total losses.

Features

- Low Conduction Loss: $V_{CE(sat)} = 2.0V @ I_C=100A$
- $V_{CE(sat)}$ with positive temperature coefficient
- Fast & Soft Anti-Parallel FWD
- Maximum junction temperature 175°C
- Short Circuit rated: 10us at $T_C=100^\circ C$
- Isolated Type Package

Applications

- High Power Converters
- Motor Drivers
- Induction Heating
- UPS (Uninterruptible Power Supplies)
- Welding Machine

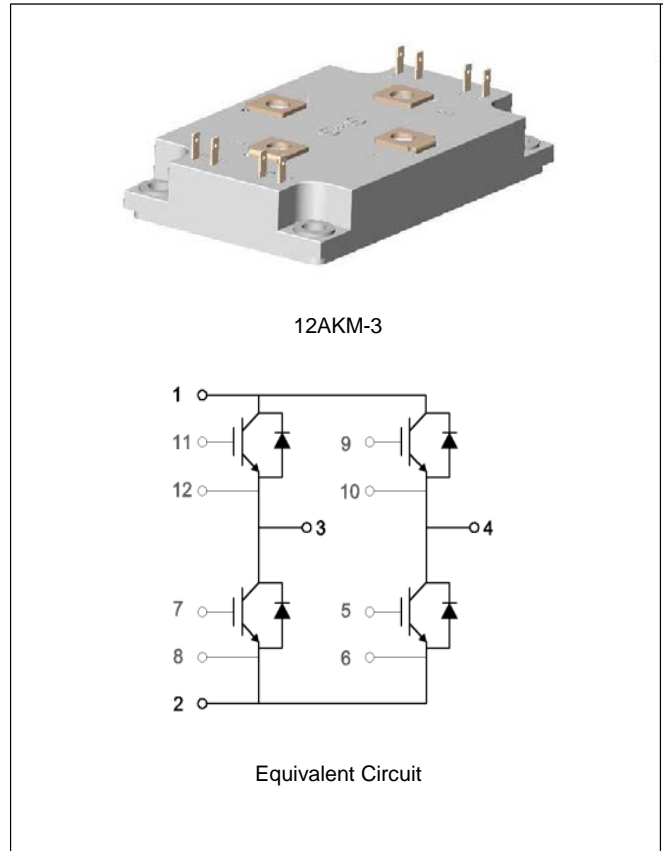

IGBT Characteristics

Absolute Maximum Ratings

Symbol	Parameter	Conditions	Value	Unit
V_{CES}	Collector to Emitter Voltage	$T_{vj}=25^\circ C$	1200	V
V_{GES}	Gate-Emitter Voltage		± 20	V
I_C	Continuous Collector Current	$T_C=25^\circ C, T_{vjmax}=175^\circ C$	175	A
		$T_C=100^\circ C, T_{vjmax}=175^\circ C$	100	
I_{CRM}	Repetitive Peak Collector Current	$t_b=1ms$	200	A
P_D	Total Power Dissipation	$T_C=25^\circ C, T_{vjmax}=175^\circ C$	625	W

Characteristic Values

Symbol	Parameter	Conditions	Value			Unit
			Min.	Typ.	Max.	
$V_{GE(th)}$	Gate-Emitter Threshold Voltage	$V_{GE}=V_{CE}, I_C=2mA, T_{vj}=25^{\circ}C$	5.0	-	6.5	V
I_{CES}	Collector-Emitter Cut-off Current	$V_{CE}=1200V, V_{GE}=0V, T_{vj}=25^{\circ}C$	-	-	0.5	mA
$V_{CE(sat)}$	Collector-Emitter Saturation Voltage	$I_C=100A, V_{GE}=15V, T_{vj}=25^{\circ}C$	-	2.0	2.8	V
		$I_C=100A, V_{GE}=15V, T_{vj}=125^{\circ}C$	-	2.48	-	
		$I_C=100A, V_{GE}=15V, T_{vj}=150^{\circ}C$	-	2.55	-	
Q_G	Gate Charge	$V_{GE} = -15V \dots +15V$	-	0.85	-	uC
C_{ies}	Input Capacitance	$V_{CE}=25V, V_{GE}=0V, f=1MHz, T_{vj}=25^{\circ}C$	-	5.85	-	nF
C_{res}	Reverse Transfer Capacitance		-	0.37	-	nF
R_{gint}	Internal Gate Resistance	$T_{vj}=25^{\circ}C$	-	5	-	Ω
I_{GES}	Gate-Emitter leakage current	$V_{CE}=0V, V_{GE}=20V, T_{vj}=25^{\circ}C$	-120	-	120	nA
$t_{d(on)}$	Turn-on Delay Time	$I_C=100A, V_{CE}=600V, V_{GE}=\pm 15V, R_G=10\Omega, T_{vj}=25^{\circ}C$	-	190	-	ns
t_r	Rise Time		-	160	-	ns
$t_{d(off)}$	Turn-off Delay Time		-	550	-	ns
t_f	Fall Time		-	110	-	ns
E_{on}	Energy Dissipation During Turn-on Time		-	18.2	-	mJ
E_{off}	Energy Dissipation During Turn-off Time		-	6.8	-	mJ
$t_{d(on)}$	Turn-on Delay Time		$I_C=100A, V_{CE}=600V, V_{GE}=\pm 15V, R_G=10\Omega, T_{vj}=125^{\circ}C$	-	220	-
t_r	Rise Time	-		170	-	ns
$t_{d(off)}$	Turn-off Delay Time	-		590	-	ns
t_f	Fall Time	-		200	-	ns
E_{on}	Energy Dissipation During Turn-on Time	-		22.3	-	mJ
E_{off}	Energy Dissipation During Turn-off Time	-		8.8	-	mJ
t_{sc}	Short Circuit Withstand Time	$V_{CC}=600V, V_{GE}=\pm 15V, R_G=10\Omega @ T_C=100^{\circ}C$		10	-	-
R_{thJC}	Thermal Resistance Junction to Case	per IGBT	-	-	0.24	$^{\circ}C/W$

Diode Characteristics

Absolute Maximum Ratings

Symbol	Parameter	Conditions	Value	Unit
V_{RRM}	Repetitive Peak Reverse Voltage	$T_{vj}=25^{\circ}\text{C}$	1200	V
I_F	Continuous DC Forward Current		75	A
I_{FRM}	Repetitive Peak Forward Current	$t_p=1\text{ms}$	150	A

Characteristic Values

Symbol	Parameter	Conditions	Value			Unit
			Min.	Typ.	Max.	
V_F	Forward Voltage	$I_F=75\text{A}, T_{vj}=25^{\circ}\text{C}$	-	1.90	2.5	V
		$I_F=75\text{A}, T_{vj}=125^{\circ}\text{C}$	-	1.65	-	
		$I_F=75\text{A}, T_{vj}=150^{\circ}\text{C}$	-	1.60	-	
Q_{rr}	Recovered Charge	$I_F=75\text{A}$ $V_R=600\text{V}$ $di_F/dt=-200\text{A/us}$ $T_{vj}=25^{\circ}\text{C}$	-	1.4	-	μC
I_{rr}	Peak Reverse Recovery Current		-	16	-	A
E_{rec}	Reverse Recovery Energy		-	3.0	-	mJ
Q_{rr}	Recovered Charge	$I_F=75\text{A}$ $V_R=600\text{V}$ $di_F/dt=-200\text{A/us}$ $T_{vj}=125^{\circ}\text{C}$	-	10	-	μC
I_{rr}	Peak Reverse Recovery Current		-	28	-	A
E_{rec}	Reverse Recovery Energy		-	5.5	-	mJ
R_{thJC}	Thermal Resistance Junction to Case	per Diode	-	-	0.45	$^{\circ}\text{C/W}$

Module Characteristics $T_c=25^\circ\text{C}$ unless otherwise specified

Symbol	Parameter	Conditions	Value			Unit
			Min.	Typ.	Max.	
V_{isol}	Isolation voltage	$t=1\text{min}, f=50\text{Hz}$	2500	-	-	V
$T_{\text{vj op}}$	Operating Junction Temperature		-55	-	175	$^\circ\text{C}$
T_{stg}	Storage Temperature		-40	-	150	$^\circ\text{C}$
L_{CE}	Stray Inductance		-	36	-	nH
$R_{\text{cc}'+\text{EE}'}$	Module Lead Resistance, Terminal to Chip	$T_c=25^\circ\text{C}$, per switch	-	1.1	-	m Ω
R_{thCS}	Thermal Resistance Case to Sink	per Package	-	0.05	-	$^\circ\text{C}/\text{W}$
M_s	Module-to-Sink Torque (M5)		3.0	-	6.0	N·m
G	Weight of Module		-	270	-	g

Typical Performance Characteristics

Fig. 1. Typical Output Characteristics

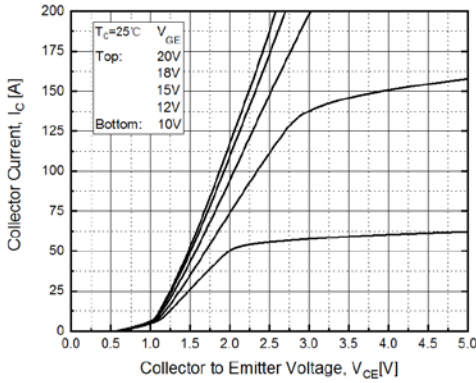

Fig. 2. Typical Output Characteristics

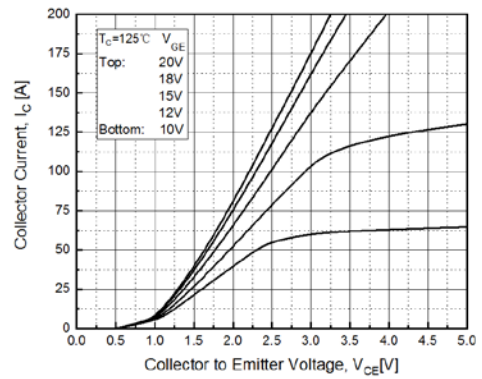

Fig. 3. Typical Saturation Voltage Characteristics

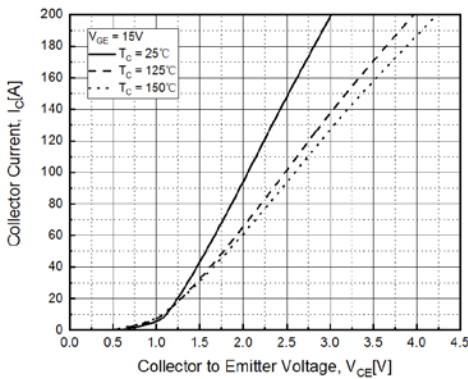

Fig. 4. Typical Transfer Characteristics

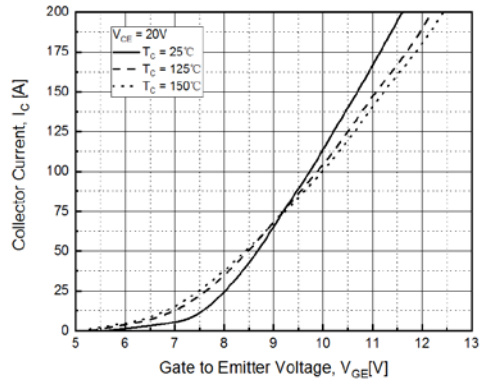

Fig. 5. Turn-on losses vs. R_G

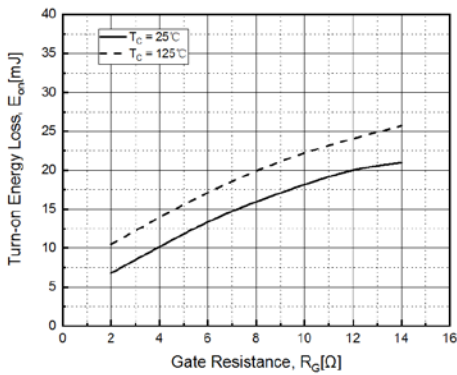
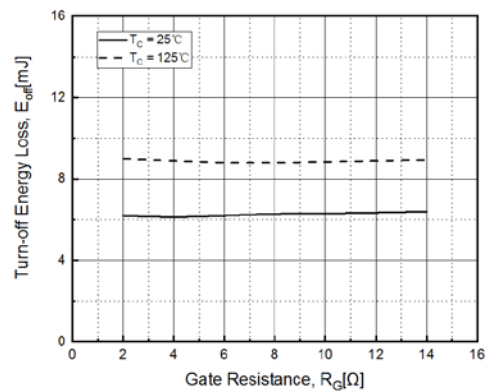

Fig. 6. Turn-off losses vs. R_G



Typical Performance Characteristics

Fig. 7. Reverse Bias Safe Operating Area

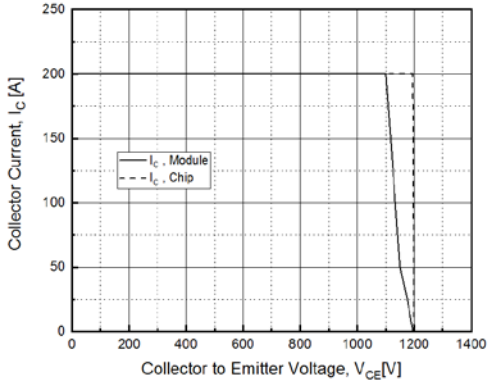

Fig. 8. Forward Characteristics of Diode

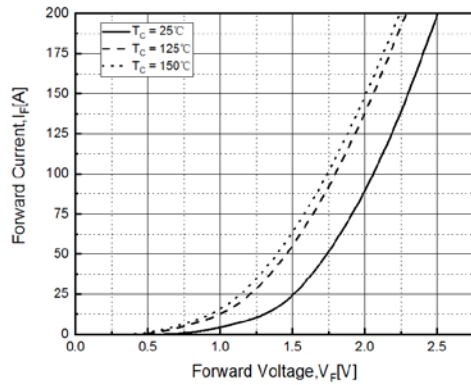

Fig. 9. Reverse Recovery Loss Characteristics vs. R_G

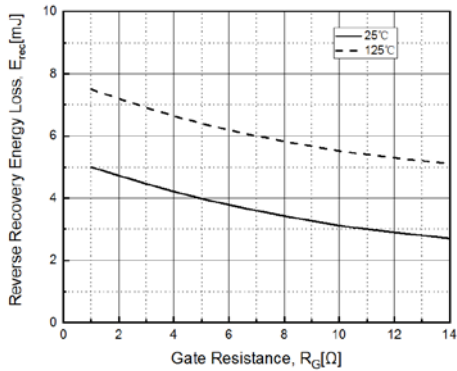
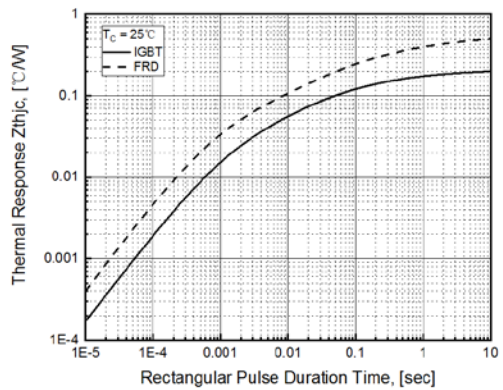
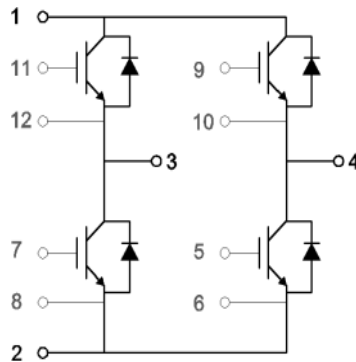

Fig. 10. Transient Thermal Impedance



Circuit Diagram



Package Dimensions

