

1700V 1Ω N-Channel SiC Power MOSFET

Description

The AKCQH1000N170 is a high blocking voltage N-Channel SiC power MOSFET. This device provide excellent performance for high voltage power supplies or pulse circuits.

Features

- Typical on-Resistance: $R_{DS(on)}=1\Omega(\text{typ.})$
- High Blocking Voltage
- 100% Avalanche Test
- Good Stability and Uniformity with High E_{AS}

Applications

- Solar Inverters
- High Voltage DC/DC Converters
- Motor Drivers
- Switch Mode Power Supplies

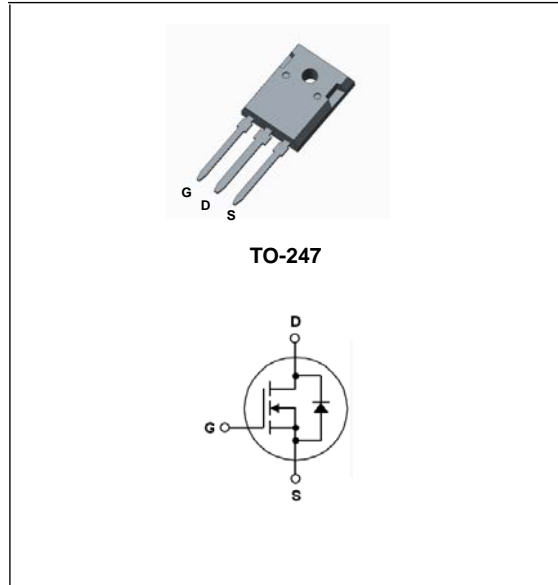

Absolute Maximum Ratings @ $T_C=25^\circ\text{C}$ unless otherwise noted

Symbol	Parameter	Ratings	Unit
V_{DSS}	Drain to Source Voltage	1700	V
V_{GSS}	Gate to Source Voltage	-10/+25	V
V_{GSop}	Recommended operation Values of Gate –Source Voltage	-5/+20	V
I_D	Drain Current	$T_C=25^\circ\text{C}$	5.0 A
		$T_C=100^\circ\text{C}$	3.0 A
I_{DM}	Pulsed Drain Current (Note1)	20.0	A
P_D	Maximum Power Dissipation	$T_C=25^\circ\text{C}$	62 W
	Derate above 25°C		0.5 W/°C
T_J	Operating Junction Temperature Range	-55~+150	°C
T_{STG}	Storage Temperature Range	-55~+150	°C

Thermal Characteristics

Symbol	Parameter	Ratings	Unit
$R_{th(J-C)}$	Thermal Resistance, Junction to case	2.02	°C/W
$R_{th(J-A)}$	Thermal Resistance, Junction to Ambient	40	°C/W

Electrical Characteristics @T_C=25 °C unless otherwise noted

Symbol	Parameter	Conditions	Min.	Typ.	Max.	Unit
BV _{DSS}	Drain to Source Breakdown Voltage	V _{GS} =0V, I _D =100uA	1700	-	-	V
V _{GS(th)}	Gate Threshold Voltage	V _{DS} =V _{GS} , I _D =1mA	2.0	2.6	4.0	V
R _{DS(on)}	Static Drain-Source On-Resistance	V _{GS} =20V, I _D =2A	-	1	1.3	Ω
I _{DSS}	Zero Gate Voltage Drain Current	V _{DS} =V _{DSS} , V _{GS} =0V	-	-	100	uA
I _{GSS}	Gate to Source Leakage Current	V _{GS} =V _{GSS} , V _{DS} =0V	-	-	±250	nA

D-S Diode Characteristics and Maximum Rating @T_C=25 °C unless otherwise noted

Symbol	Parameter	Conditions	Min.	Typ.	Max.	Unit
V _{SD}	Drain-Source Diode Forward Voltage	V _{GS} =-5V, I _S =1A	-	4.2	-	V
t _{rr}	Reverse Recovery Time	V _{GS} =0V, I _S =2A, di/dt=-290A/us	-	25	-	ns
Q _{rr}	Reverse Recovery Charge		-	15	-	nC

Switching Characteristics @T_C=25 °C unless otherwise noted

Symbol	Parameter	Conditions	Min.	Typ.	Max.	Unit
t _{d(on)}	Turn-on Delay Time	I _D =30A , V _{DD} =1200V, R _G =2.5Ω V _{GS} = -5/20V, (Note 3)	-	5	-	ns
t _r	Turn-on Rise Time		-	9.2	-	ns
t _{d(off)}	Turn-off Delay Time		-	13.8	-	ns
t _f	Turn-off Fall Time		-	22.8	-	ns
E _{ON}	Turn-On Switching Energy	V _{DS} =1200V, V _{GS} =-5V/20V I _D =2A, R _{G(ext)} =2.5Ω, L=1500μH	-	5.1	-	uJ
E _{Off}	Turn-Off Switching Energy		-	9.2	-	uJ
C _{iss}	Input Capacitance	V _{GS} =0V, V _{DS} =1000V, f=1.0MHz	-	194	-	pF
C _{oss}	Output Capacitance		-	13	-	pF
C _{rss}	Reverse Transfer Capacitance		-	1.8	-	pF
Q _g	Total Gate Charge	I _D =2A, V _{DD} =1200V V _{GS} =-5V/20V (Note 3)	-	23	-	nC
Q _{gs}	Gate to Source Charge		-	5.4	-	nC
Q _{gd}	Gate to Drain Charge		-	7.6	-	nC

Note:

1. Repetitive rating: pulse-width limited by maximum junction temperature
2. V_{DD}=100V, L=1mH, V_G=10V, I_D=2.0A
3. Essentially independent of operating temperature typical characteristics.

Typical Performance Characteristics

Fig. 1. Typical on-Resistance Characteristics

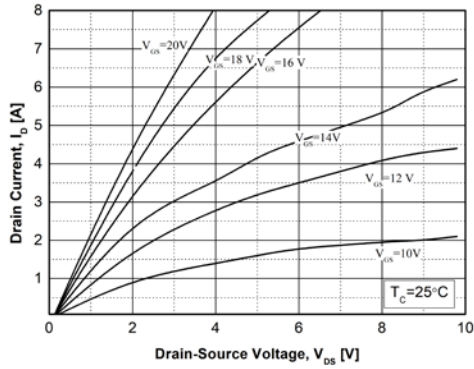

Fig. 2. Typical on-Resistance Characteristics

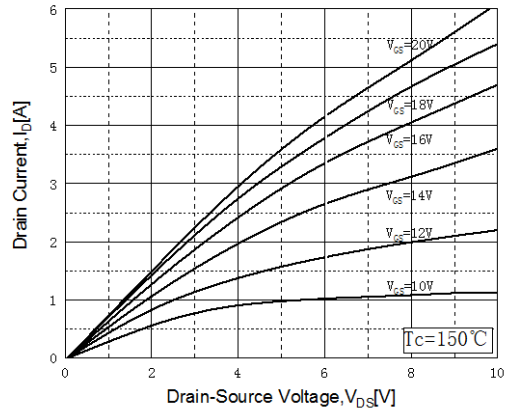

Fig. 3 Normalized On-Resistance vs. Drain Current and Gate Voltage

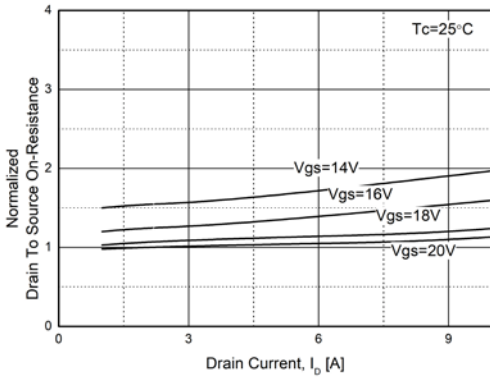

Fig. 4. Normalized On-Resistance vs. Junction Temperature

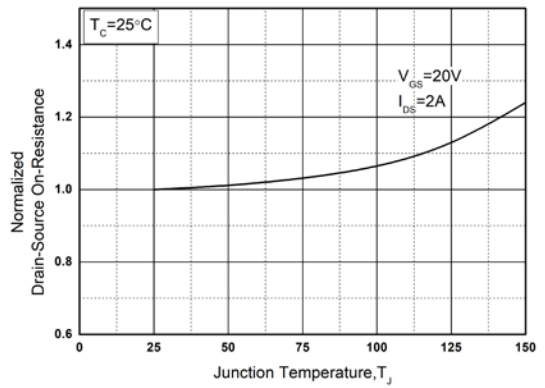

Fig. 5. On-Resistance vs. Drain Current

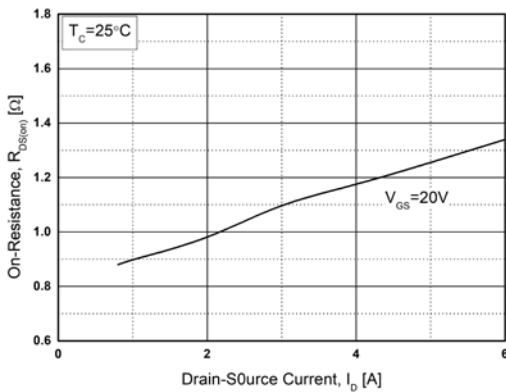
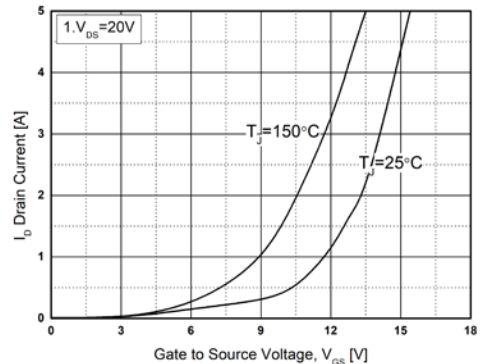

Fig. 6. Transfer Characteristics



Typical Performance Characteristics

Fig. 7. Source-to-Drain Diode Forward Voltage vs. Source Current

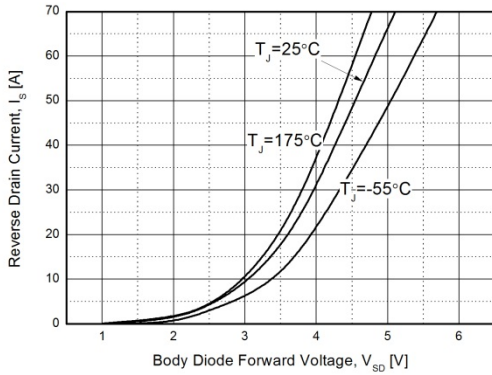

Fig. 8. Gate Charge Characteristics

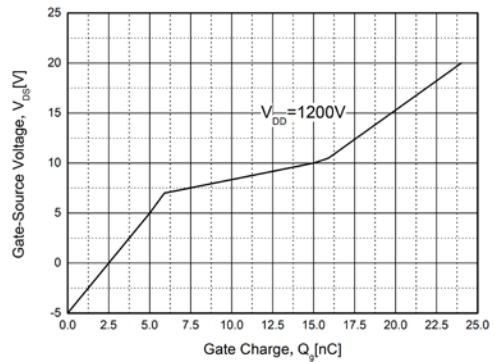

Fig. 9. Characteristics vs. Drain-to-Source Voltage

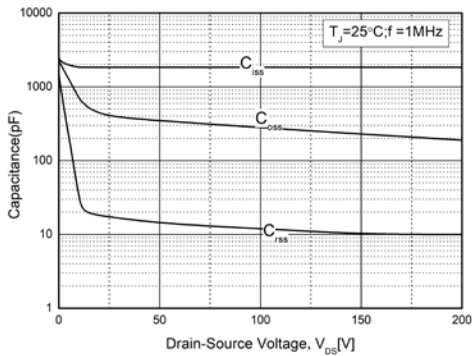
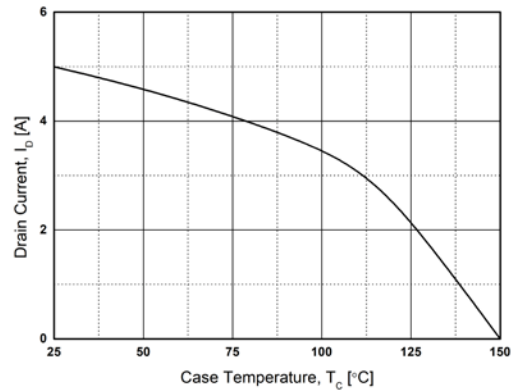

Fig.10. Maximum Drain Current vs. Temperature



Package Dimensions

TO-247

(Dimensions in Millimeters)

