

## 1200V 40mΩ N-Channel SiC Power MOSFET

### Description

The AKCQH040N120 is a high blocking voltage N-Channel SiC power MOSFET. This device provide excellent performance for high voltage power supplies or pulse circuits.

### Features

- Typical on-Resistance:  $R_{DS(on)}=40m\Omega(\text{typ.})$
- High Blocking Voltage
- 100% Avalanche Test
- Good Stability and Uniformity with High  $E_{AS}$

### Applications

- Solar Inverters
- High Voltage DC/DC Converters
- Motor Drivers
- Switch Mode Power Supplies

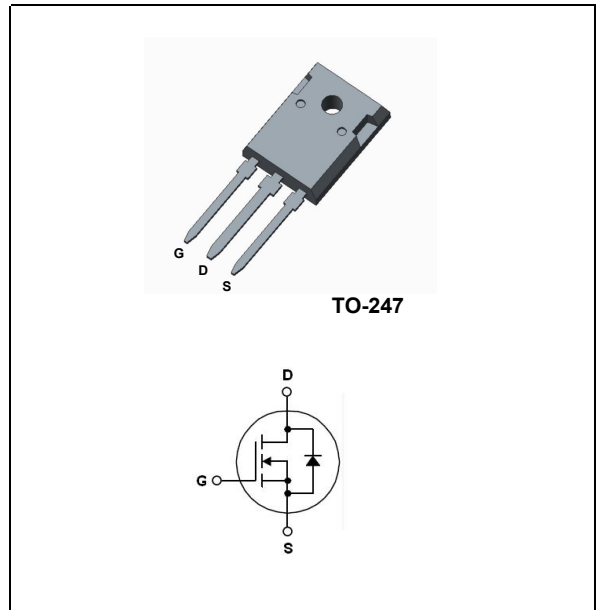

### Absolute Maximum Ratings @ $T_C=25^\circ\text{C}$ unless otherwise noted

Symbol	Parameter	Ratings	Unit	
$V_{DSS}$	Drain to Source Voltage	1200	V	
$V_{GSS}$	Gate to Source Voltage	-10/+25	V	
$V_{GSop}$	Recommended operation Values of Gate –Source Voltage	-5/+20	V	
$I_D$	Drain Current	$T_C=25^\circ\text{C}$	61	A
		$T_C=100^\circ\text{C}$	42	A
$I_{DM}$	Pulsed Drain Current (Note1)	120	A	
$P_D$	Maximum Power Dissipation	$T_C=25^\circ\text{C}$	250	W
	Derate above $25^\circ\text{C}$		1.67	W/ $^\circ\text{C}$
$E_{AS}$	Single Pulsed Avalanche Energy (Note 2)	300	mJ	
$T_J$	Operating Junction Temperature Range	-50~+175	$^\circ\text{C}$	
$T_{STG}$	Storage Temperature Range	-50~+175	$^\circ\text{C}$	

### Thermal Characteristics

Symbol	Parameter	Ratings	Unit
$R_{th(J-C)}$	Thermal Resistance, Junction to case	0.6	$^\circ\text{C}/\text{W}$
$R_{th(J-A)}$	Thermal Resistance, Junction to Ambient	40	$^\circ\text{C}/\text{W}$

## Electrical Characteristics @ $T_c=25\text{ }^\circ\text{C}$ unless otherwise noted

Symbol	Parameter	Conditions	Min.	Typ.	Max.	Unit
$BV_{DSS}$	Drain to Source Breakdown Voltage	$V_{GS}=0V, I_D=2mA$	1200	-	-	V
$V_{GS(th)}$	Gate Threshold Voltage	$V_{DS}=V_{GS}, I_D=5mA$	2.0	2.5	4.0	V
$R_{DS(on)}$	Static Drain-Source On-Resistance	$V_{GS}=20V, I_D=20A$	-	44	65	m $\Omega$
$I_{DSS}$	Zero Gate Voltage Drain Current	$V_{DS}=V_{DSS}, V_{GS}=0V$	-	-	100	$\mu A$
$I_{GSS}$	Gate to Source Leakage Current	$V_{GS}=V_{GSS}, V_{DS}=0V$	-	-	$\pm 500$	nA

## D-S Diode Characteristics and Maximum Rating @ $T_c=25\text{ }^\circ\text{C}$ unless otherwise noted

Symbol	Parameter	Conditions	Min.	Typ.	Max.	Unit
$V_{SD}$	Drain-Source Diode Forward Voltage	$V_{GS}=0V, I_S=40A$	-	3.9	-	V
$t_{rr}$	Reverse Recovery Time	$V_{GS}=0V, I_S=40A,$ $di/dt=-290A/\mu s$	-	30	-	ns
$Q_{rr}$	Reverse Recovery Charge		-	590	-	nC

## Switching Characteristics @ $T_c=25\text{ }^\circ\text{C}$ unless otherwise noted

Symbol	Parameter	Conditions	Min.	Typ.	Max.	Unit
$t_{d(on)}$	Turn-on Delay Time	$I_D=40A,$ $V_{DD}=800V,$ $R_G=2.5\Omega$ $V_{GS} = -5/20V,$ (Note 3)	-	12	-	ns
$t_r$	Turn-on Rise Time		-	12	-	ns
$t_{d(off)}$	Turn-off Delay Time		-	23	-	ns
$t_f$	Turn-off Fall Time		-	6.7	-	ns
$C_{iss}$	Input Capacitance	$V_{GS}=0V, V_{DS}=1000V,$ $f=1.0MHz$	-	2946	-	pF
$C_{oss}$	Output Capacitance		-	167	-	pF
$C_{riss}$	Reverse Transfer Capacitance		-	6.6	-	pF
$Q_g$	Total Gate Charge	$I_D=40A,$ $V_{DD}=800V$ $V_{GS}=-5V/20V$ (Note 3)	-	142	-	nC
$Q_{ge}$	Gate to Source Charge		-	37	-	nC
$Q_{gd}$	Gate to Drain Charge		-	18	-	nC

### Note:

1. Repetitive rating: pulse-width limited by maximum junction temperature
2.  $V_{DD}=100V, L=10mH, V_{clamp}=1600V, V_G=10V, I_D=19.0A$
3. Essentially independent of operating temperature typical characteristics

**Typical Performance Characteristics**

Fig. 1. Typical on-Resistance Characteristics

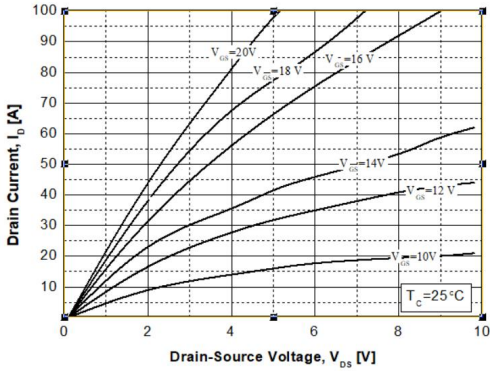

Fig. 2. Normalized On-Resistance vs. Drain Current and Gate Voltage

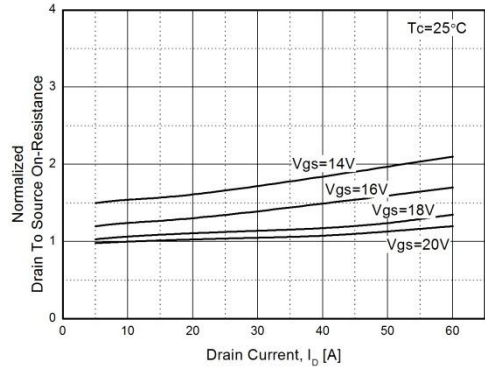

Fig. 3. Normalized On-Resistance vs. Junction Temperature

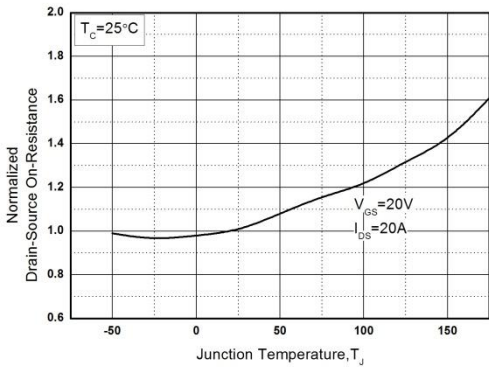

Fig. 4. On-Resistance vs. Gate-to-source Voltage

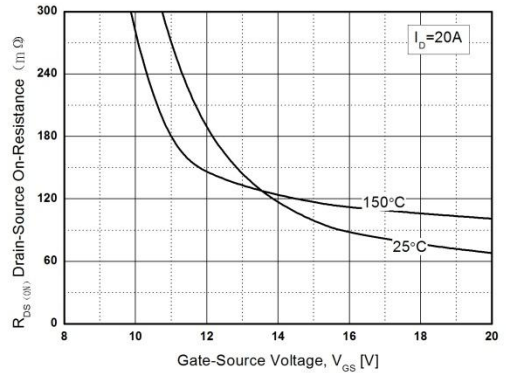

Fig. 5. Transfer Characteristics

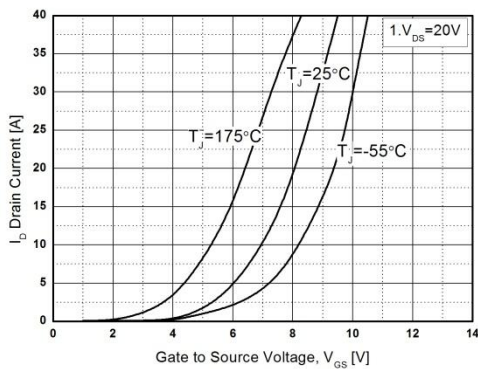
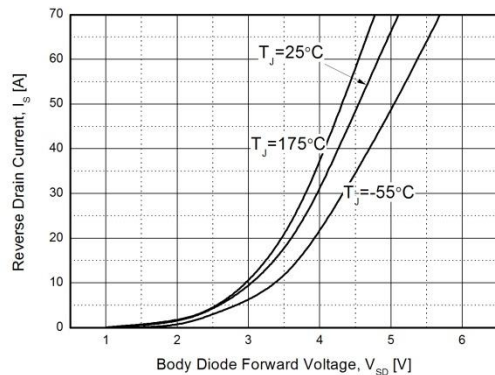

Fig. 6. Source-to-Drain Diode Forward Voltage vs. Source Current



**Typical Performance Characteristics**

Fig. 7. Gate Charge Characteristics

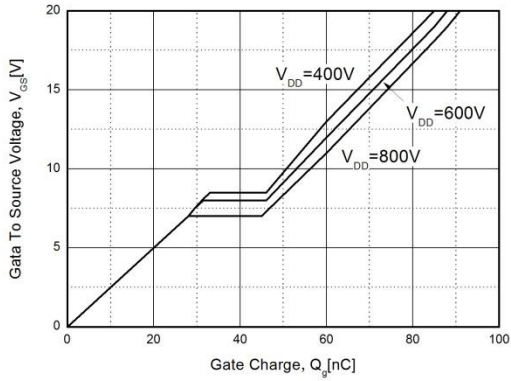

Fig. 8. Characteristics vs. Drain-to-Source Voltage

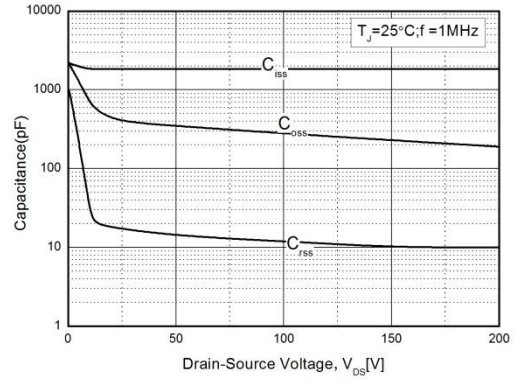
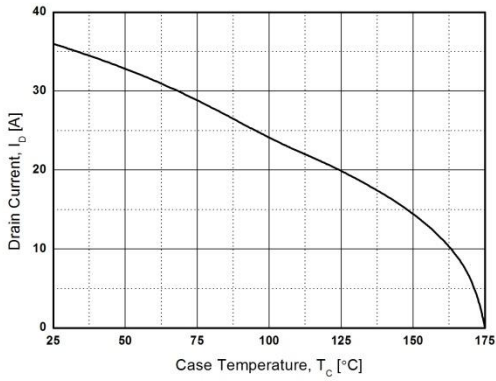

Fig. 9. Maximum Drain Current vs. Temperature



**Package Dimensions**

**TO-247**

(Dimensions in Millimeters)

