

1200V 25mΩ N-Channel SiC Power MOSFET

Description

The AKCQH025N120L4 is a high blocking voltage N-Channel SiC power MOSFET. This device provide excellent performance for high voltage power supplies or pulse circuits.

Features

- Typical on-Resistance: $R_{DS(on)}=25m\Omega(\text{typ.})$
- High Blocking Voltage
- 100% Avalanche Test
- Good Stability and Uniformity with High E_{AS}

Applications

- Solar Inverters
- High Voltage DC/DC Converters
- Motor Drivers
- Switch Mode Power Supplies

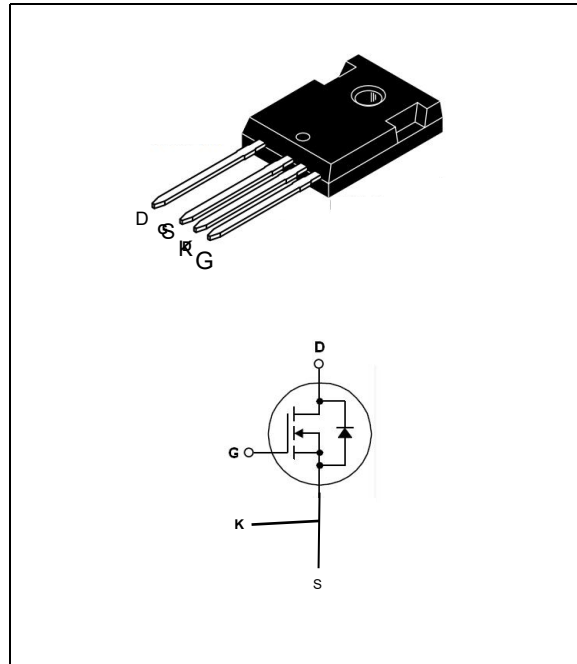

Absolute Maximum Ratings @ $T_C=25^\circ\text{C}$ unless otherwise noted

Symbol	Parameter	Ratings	Unit
V_{DSS}	Drain to Source Voltage	1200	V
V_{GSS}	Gate to Source Voltage	-10/+25	V
V_{GSop}	Recommended operation Values of Gate –Source Voltage	-5/+20	V
I_D	Drain Current	$T_C=25^\circ\text{C}$	90
		$T_C=100^\circ\text{C}$	60
I_{DM}	Pulsed Drain Current (Note1)	240	A
P_D	Maximum Power Dissipation	$T_C=25^\circ\text{C}$	500
	Derate above 25°C		3.33
E_{AS}	Single Pulsed Avalanche Energy (Note 2)	300	mJ
T_J	Operating Junction Temperature Range	-40~+175	$^\circ\text{C}$
T_{STG}	Storage Temperature Range	-40~+175	$^\circ\text{C}$

Thermal Characteristics

Symbol	Parameter	Ratings	Unit
$R_{th(J-C)}$	Thermal Resistance, Junction to case	0.3	$^\circ\text{C/W}$
$R_{th(J-A)}$	Thermal Resistance, Junction to Ambient	40	$^\circ\text{C/W}$

Electrical Characteristics @T_c=25 °C unless otherwise noted

Symbol	Parameter	Conditions	Min.	Typ.	Max.	Unit
BV _{DSS}	Drain to Source Breakdown Voltage	V _{GS} =0V, I _D =100uA	1200	-	-	V
V _{GS(th)}	Gate Threshold Voltage	V _{DS} =V _{GS} , I _D =15mA	1.9	2.4	-	V
R _{DS(on)}	Static Drain-Source On-Resistance	V _{GS} =20V, I _D =50A	-	25	45	mΩ
I _{DSS}	Zero Gate Voltage Drain Current	V _{DS} =V _{DSS} , V _{GS} =0V	-	-	100	uA
I _{GSS}	Gate to Source Leakage Current	V _{GS} =V _{GSS} , V _{DS} =0V	-	-	±500	nA

D-S Diode Characteristics and Maximum Rating @T_c=25 °C unless otherwise noted

Symbol	Parameter	Conditions	Min.	Typ.	Max.	Unit
V _{SD}	Drain-Source Diode Forward Voltage	V _{GS} =0V, I _S =25A	-	2.6	-	V
t _{rr}	Reverse Recovery Time	V _{GS} =0V, I _S =25A, di/dt=-1000A/us	-	55	-	ns
Q _{rr}	Reverse Recovery Charge		-	220	-	nC

Switching Characteristics @T_c=25 °C unless otherwise noted

Symbol	Parameter	Conditions	Min.	Typ.	Max.	Unit
t _{d(on)}	Turn-on Delay Time	I _D =50A , V _{DD} =800V, R _G =2.5Ω V _{GS} = -5/20V, (Note 3)	-	16	-	ns
t _r	Turn-on Rise Time		-	16.2	-	ns
t _{d(off)}	Turn-off Delay Time		-	33	-	ns
t _f	Turn-off Fall Time		-	7.8	-	ns
C _{iss}	Input Capacitance	V _{GS} =0V, V _{DS} =1000V, f=1.0MHz	-	3600	-	pF
C _{oss}	Output Capacitance		-	240	-	pF
C _{rss}	Reverse Transfer Capacitance		-	16	-	pF
Q _g	Total Gate Charge	I _D =50A, V _{DD} =800V V _{GS} =-5V/20V (Note 3)	-	195	-	nC
Q _{ge}	Gate to Source Charge		-	54	-	nC
Q _{gd}	Gate to Drain Charge		-	29	-	nC

Note:

1. Repetitive rating: pulse-width limited by maximum junction temperature
2. V_{DD}=100V, L=10mH, V_{clamp}=1600V, V_G=10V, I_D=23.0A
3. Essentially independent of operating temperature typical characteristics

Typical Performance Characteristics

Fig. 1. Typical on-Resistance Characteristics

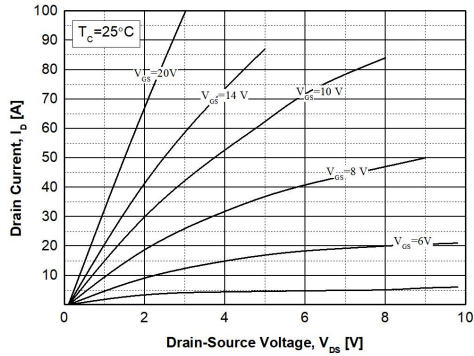

Fig. 2. Normalized On-Resistance vs. Drain Current and Gate Voltage

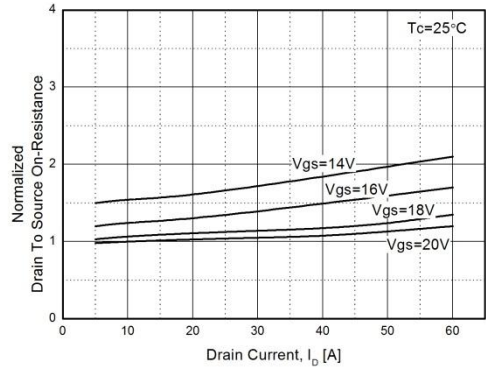

Fig. 3. Normalized On-Resistance vs. Junction Temperature

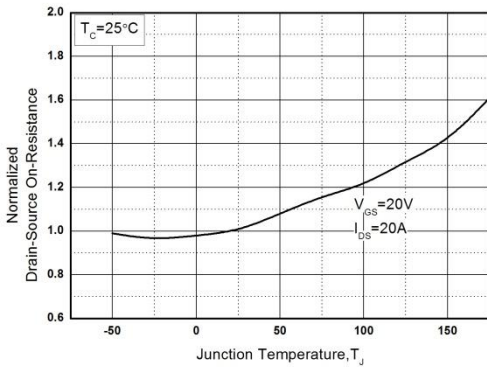

Fig. 4. On-Resistance vs. Gate-to-source Voltage

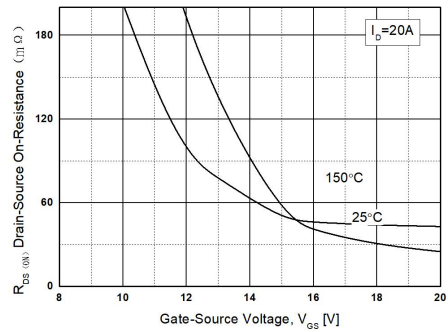

Fig. 5. Transfer Characteristics

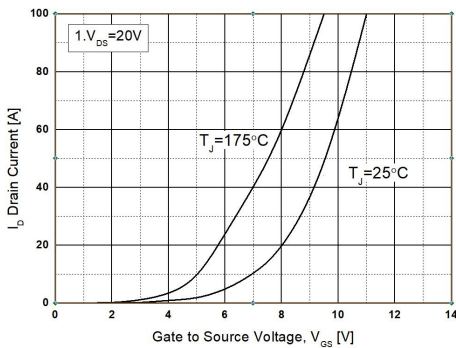
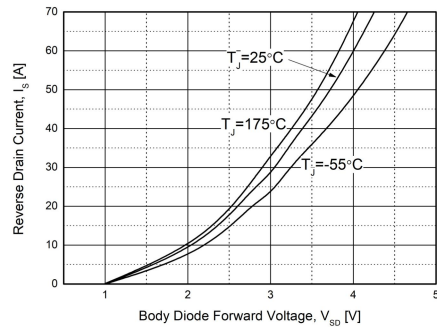

Fig. 6. Source-to-Drain Diode Forward Voltage vs. Source Current



Typical Performance Characteristics

Fig. 7. Gate Charge Characteristics

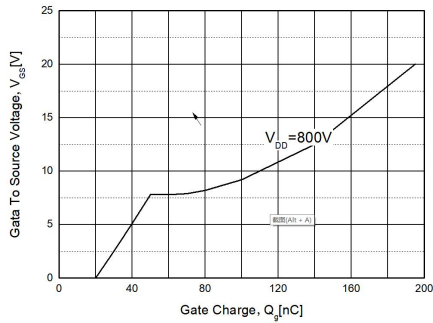

Fig. 8. Characteristics vs. Drain-to-Source Voltage

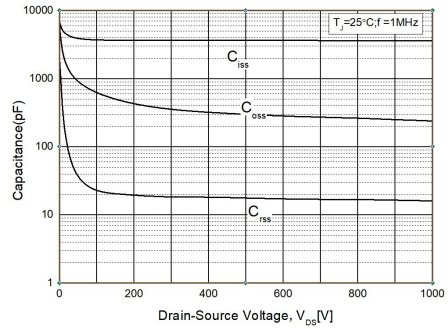
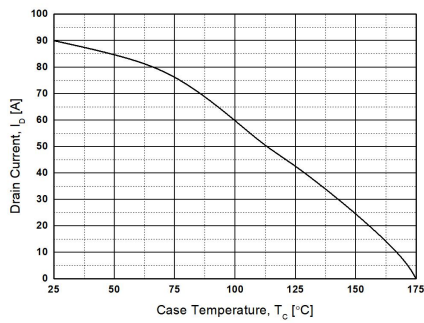

Fig. 9. Maximum Drain Current vs. Temperature



Package Dimensions

TO-247

(Dimensions in Millimeters)

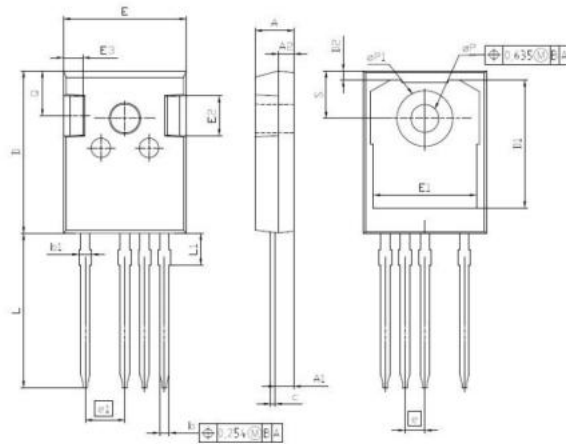

DIM	MILLIMETERS		INCHES	
	MIN	MAX	MIN	MAX
A	4.83	5.21	0.190	0.205
A1	2.29	2.54	0.090	0.100
A2	1.90	2.16	0.075	0.085
b	1.07	1.33	0.042	0.052
b1	1.10	1.70	0.043	0.067
c	0.50	0.70	0.020	0.028
D	20.80	21.10	0.819	0.831
D1	16.25	17.65	0.640	0.695
D2	0.95	1.35	0.037	0.053
E	15.70	16.13	0.618	0.635
E1	13.10	14.15	0.516	0.557
E2	3.68	5.10	0.145	0.201
E3	1.00	2.60	0.039	0.102
e	2.54 (BSC)		0.100 (BSC)	
e1	5.08		0.200	
N	4		4	
L	19.72	20.32	0.776	0.800
L1	4.02	4.40	0.158	0.173
eP	3.50	3.70	0.138	0.146
eP1	7.00	7.40	0.276	0.291
Q	5.49	6.00	0.216	0.236
S	6.04	6.30	0.238	0.248