

## NPT & Rugged Type 1200V IGBT Module

### Description

The IGBT Module 12AKM-1 package devices are optimized to reduce losses and switching noise in high frequency power conditioning electrical systems.

These IGBT Module series are ideally suited for IH ,High Power inverters, Motors drives and other applications where switching losses are significant portion of the total losses.

### Features

- $BV_{CES}=1200V$
- Low Conduction Loss:  $V_{CE(sat)} = 2.8 V @ I_C=40A$
- Fast & Soft Anti-Parallel FWD
- Short Circuit rated:10us at  $T_C=100^\circ C$
- Isolation Type Package

### Applications

- Induction Heating, Motor Drives, High Power Inverters
- Welding Machine, UPS

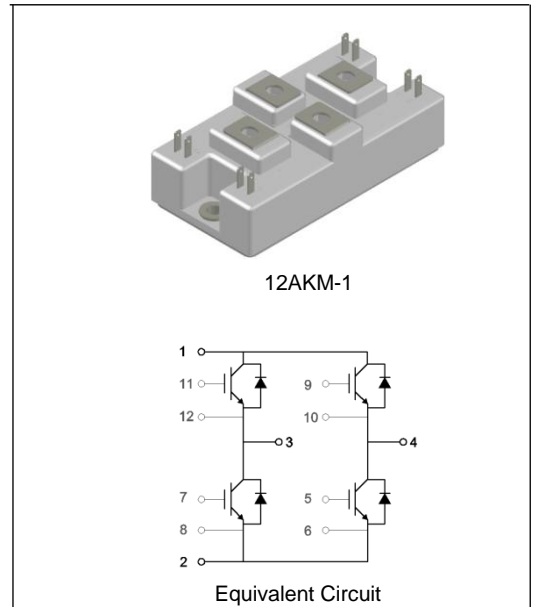

### Absolute Maximum Ratings (at $T_C=25^\circ C$ unless otherwise noted)

Symbol	Parameter	Ratings	Unit	
$V_{CES}$	Collector to Emitter Voltage	1200	V	
$V_{GES}$	Gate to Emitter Voltage	$\pm 20$	V	
$I_C$	Collector Current	$T_C=25^\circ C$	60	A
		$T_C=100^\circ C$	40	A
$I_{CM}$	Pulsed Collector Current , $t_p=1ms$	80	A	
$I_F$	Diode Continuous Forward Current	$T_C=100^\circ C$	40	A
$I_{FM}$	Diode Maximum Forward Current	80	A	
$P_D$	Maximum Power Dissipation	$T_C=25^\circ C$	416	W
$T_J$	Operating Junction Temperature Range	-55~+150	$^\circ C$	
$T_{STG}$	Storage Temperature Range	-55~+125	$^\circ C$	
$V_{iso}$	Isolation Voltage	AC 1minute	2500	V
	Mounting screw Torque: M6	4	N.M	
	Weight	155	g	

### Thermal Characteristics

Symbol	Parameter	Ratings	Unit
$R_{th(J-C)}$ (IGBT)	Thermal Resistance, Junction to case for IGBT	0.3	$^\circ C/W$
$R_{th(J-C)}$ (Diode)	Thermal Resistance, Junction to case for Diode	0.8	$^\circ C/W$
$R_{th(J-A)}$	Thermal Resistance, Junction to Ambient	0.05	$^\circ C/W$

## Electrical Characteristics of IGBT @ $T_C=25\text{ }^\circ\text{C}$ unless otherwise noted

Symbol	Parameter	Conditions	Min.	Typ.	Max.	Unit
$BV_{CES}$	Collector to Emitter Breakdown Voltage	$V_{GE}=0V, I_C=1mA$	1200	-	-	V
$V_{CE(sat)}$	Collector to Emitter Saturation Voltage	$I_C=40A, V_{GE}=15V$	-	2.8	3.8	V
		$I_C=40A, V_{GE}=15V, T_C=100\text{ }^\circ\text{C}$	-	3.3	-	V
$V_{GE(th)}$	Gate Threshold Voltage	$V_{CE}=V_{GE}, I_C=2mA$	4.5	-	7.5	V
$I_{CES}$	Zero Gate Voltage Collector Current	$V_{CE}=V_{CES}, V_{GE}=0V$	-	-	1	mA
$I_{GES}$	Gate to Emitter Leakage Current	$V_{GE}=V_{GES}, V_{CE}=0V$	-	-	$\pm 250$	nA

## Electrical Characteristics of Diode @ $T_C=25\text{ }^\circ\text{C}$ unless otherwise noted

Symbol	Parameter	Conditions	Min.	Typ.	Max.	Unit
$V_F$	Diode Forward Voltage	$I_F=40A$	-	2.8	3.5	V
		$I_F=40A, T_C=100\text{ }^\circ\text{C}$	-	2.4	-	V
$t_{rr}$	Diode Reverse Recovery Time	$I_F=40A, di/dt=-200A/us$	-	80	-	ns
$I_{rr}$	Diode Peak Reverse Recovery Current		-	9.0	-	A
$Q_{rr}$	Diode Reverse Recovery Charge		-	240	-	nC
$t_{rr}$	Diode Reverse Recovery Time	$I_F=40A, di/dt=-200A/us, T_C=100\text{ }^\circ\text{C}$	-	150	-	ns
$I_{rr}$	Diode Peak Reverse Recovery Current		-	14	-	A
$Q_{rr}$	Diode Reverse Recovery Charge		-	850	-	nC

## Switching Characteristics @ $T_C=25\text{ }^\circ\text{C}$ unless otherwise noted

Symbol	Parameter	Conditions	Min.	Typ.	Max.	Unit	
$t_{d(on)}$	Turn-on Delay Time	$I_C=40A, V_{CC}=600V, V_{GE}=\pm 15V, R_G=10\Omega, \text{Inductive Load}$	-	85	-	ns	
$t_r$	Rise Time		-	90	-	ns	
$t_{d(off)}$	Turn-off Delay Time		-	250	-	ns	
$t_f$	Fall Time		-	50	-	ns	
$E_{on}$	Turn-on Switching Loss		-	3.6	-	mJ	
$E_{off}$	Turn-off Switching Loss		-	3.0	-	mJ	
$E_{ts}$	Total Switching Loss		-	6.6	-	mJ	
$C_{ies}$	Input Capacitance		$V_{GE}=0V, V_{CE}=30V, f=1.0MHz$	-	3400	-	pF
$C_{res}$	Reverse Transfer Capacitance			-	370	-	pF
$C_{oes}$	Output Capacitance	-		125	-	pF	
$Q_g$	Total Gate Charge	$I_C=40A, V_{CC}=600V, V_{GE}=\pm 15V$	-	220	-	nC	
$Q_{ge}$	Gate to Emitter Charge		-	25	-	nC	
$Q_{gc}$	Gate to Collector Charge		-	130	-	nC	
$t_{sc}$	Short Circuit Withstand Time	$V_{CC}=600V, V_{GE}=\pm 15V, R_G=10\Omega @T_C=100\text{ }^\circ\text{C}$	10	-	-	us	

**Typical Performance Characteristics**

Fig. 1. Typical Output Characteristics

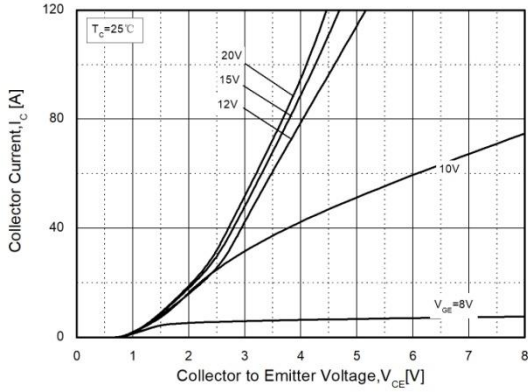

Fig. 2. Typical Output Characteristics

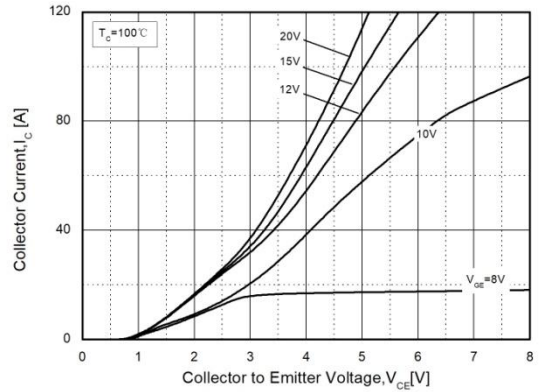

Fig. 3. Typical Saturation Voltage Characteristics

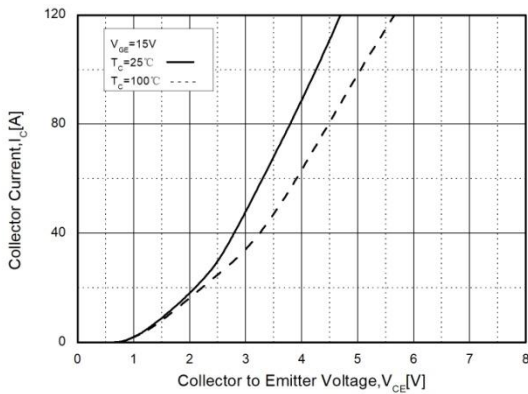

Fig. 4. Gate Charge Characteristics

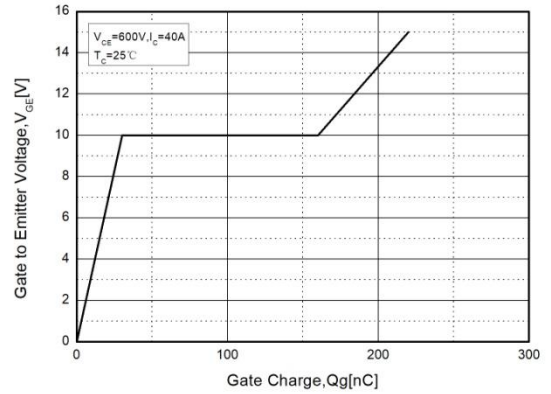

Fig. 5. Turn-on Characteristics vs.  $R_G$

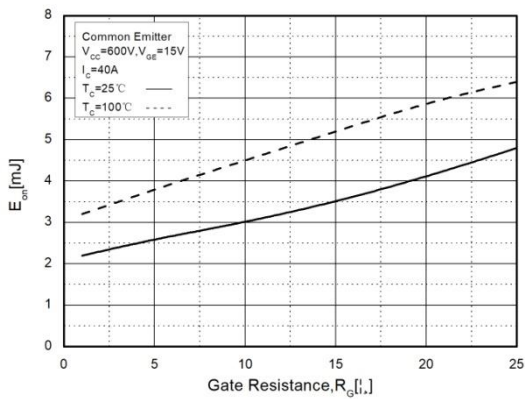
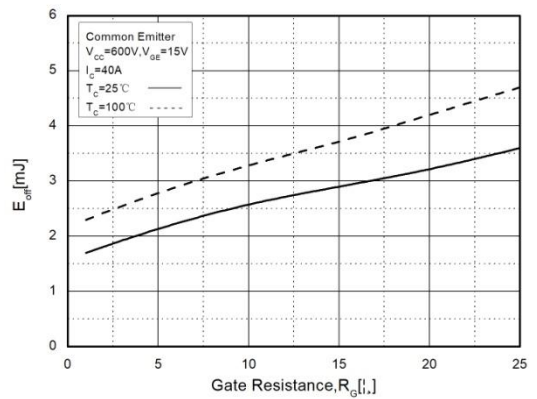

Fig. 6. Turn-off Characteristics vs.  $R_G$



**Typical Performance Characteristics**

Fig. 7. Rate Current vs.  $T_C$

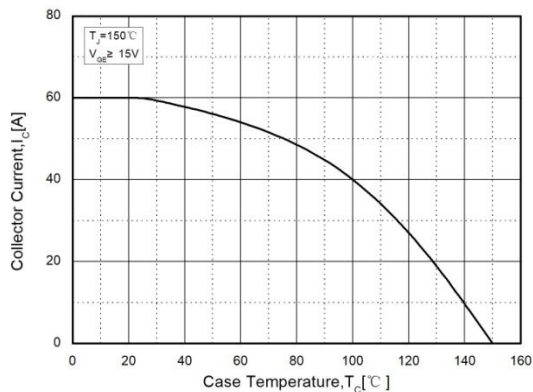

Fig. 8. Power Dissipation vs.  $T_C$

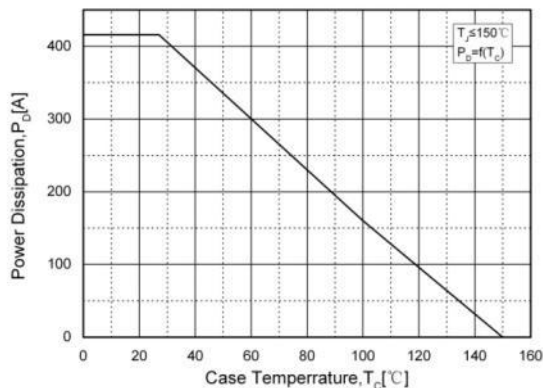

Fig. 9. Transient Thermal Impedance

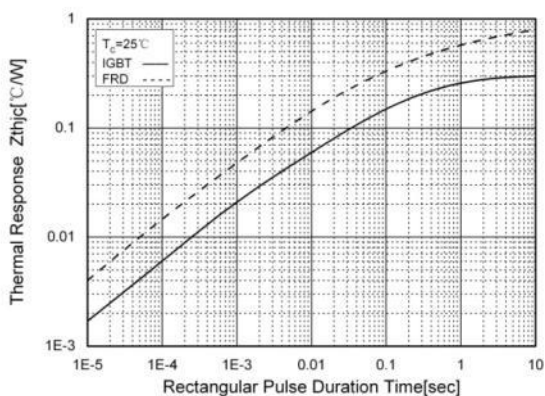
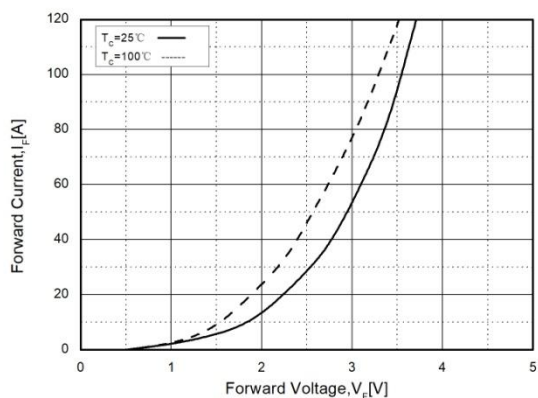
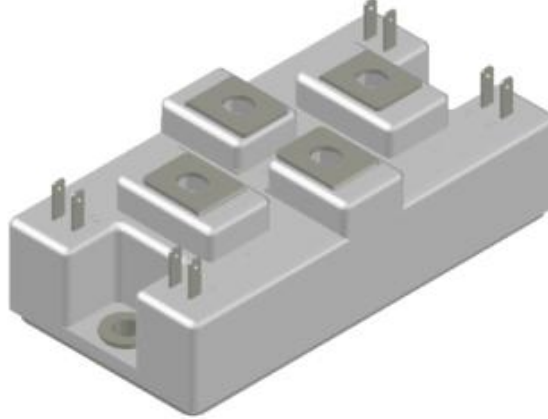

Fig. 10. Forward Characteristics



**Package Dimensions**

**12AKM-1**



(Dimensions in Millimeters)

